

”

Unser Engagement für  
Nachhaltigkeit auch anderen  
mitgeben zu können:  
Das ist ein gutes Gefühl.

To be able to share our commitment to  
sustainability with others:  
That's a good feeling.

2022/2023

Werbeschreibgeräte

Promotional writing instruments

CO<sub>2</sub>

neutrale Produkte  
neutral products

# Markenqualität Made in Germany

Brand Quality  
Made in Germany



[www.blauer-engel.de/uz200](http://www.blauer-engel.de/uz200)



\* Die Auszeichnung mit dem Umweltzeichen "Blauer Engel" gilt nur für das Modell Reco (links im Bild).

\* The "Blue Angel" eco-label only applies to the model Reco (on the left in the picture).

Wir sind stolz darauf, dass wir seit Jahrzehnten für eines stehen: Schreibgeräte für jedermann. Wir sind für alle da, aber das macht unseren Anspruch keineswegs beliebig. Verlassen Sie sich auch 2022/23 auf ein Angebot bestehend aus hochwertigen, alltagstauglichen und nachhaltigen Produkten „Made in Germany“. Gibt es eine schönere Art, Wertschätzung zu verschenken?

---

We are proud to say that we have stood for one thing for decades: Pens for everyone. We are there for everyone, but that does not make our claim arbitrary at all. In 2022/23, you can once again rely on a product range consisting of high-quality, sustainable products "Made in Germany" which are ideal for your everyday life. Is there a more beautiful way to express appreciation?

*Christian Schneider*

Benötigen Sie Hilfe bei der Auswahl oder haben Sie Fragen zu unseren Produkten? Mein Team und ich sind gerne persönlich für Sie da.

---

Do you need help with your selection or do you have questions about our products? My team and I are happy to help you personally.



---

**Klaus Broghammer**

+49 (0) 7729 - 888 124

[promotion@schneiderpen.com](mailto:promotion@schneiderpen.com)

Verkauf ausschließlich über unsere Handelspartner.

We sell our products exclusively through trading partners.

---

2

## **Markenqualität Made in Germany**

Brand quality  
Made in Germany

6

## **Unternehmensportrait**

Company profile

8

## **Nachhaltigkeit bei Schneider**

Sustainability at Schneider

12

## **Produkt-Highlights**

Product highlights

14

## **Druckverfahren**

Printing techniques

---

16

## **Produktverzeichnis**

List of products

18

## **Kugelschreiber**

Ballpoint Pens

110

## **Universal-Halterung**

Universal Holders

118

## **Textmarker**

Highlighters

130

## **Permanent Marker**

Permanent Markers

138

## **Fineliner**

Fineliners

150

## **Füller & Tintenroller**

Fountain Pens & Rollerballs

164

## **Etuis**

Wallets

165

## **Auszeichnungen**

Awards

166

## **Technische Daten**

Technical details



---

**Christian Schneider**

Geschäftsführer und Inhaber der  
Schneider Schreibgeräte GmbH

Managing Director and owner of  
Schneider Schreibgeräte GmbH

# Pionier der Schreibtechnik

## Pioneer of writing technology

Der Kugelschreiber ist der unangefochtene Liebling unter den Werbeartikeln – und wir sind seit über 80 Jahren die fachkundigen Experten, was seine Herstellung angeht. Qualität, Innovationskraft und ein klares Bekenntnis zur Nachhaltigkeit haben dazu geführt, dass sechs der zehn meistverkauften Kugelschreiber in Deutschland von Schneider kommen.\* Um unsere Herstellungsprozesse permanent überprüfen und optimieren zu können, entwickeln und produzieren wir in Deutschland an den Standorten in Schramberg/Schwarzwald und in Wernigerode/Harz. Wenn Sie sich für Schneider entscheiden, entscheiden Sie sich bewusst für Qualität „Made in Germany“.

The ballpoint pen is the unrivalled favourite among promotional products – and we have been the experts in its manufacture for over 80 years. Quality, innovative power and a clear commitment to being sustainable are the reasons why six of the ten best-selling ballpoint pens in Germany are made by Schneider.\* In order to be able to permanently review and optimise our manufacturing processes, we develop and produce in Germany at our facilities in Schramberg/Black Forest and in Wernigerode/Harz. When you decide to buy Schneider products, you are making a conscious decision for quality "Made in Germany".



Produktionsstandorte  
Production sites

\* GfK Retail & Technology, GfK Panelmarkt Kugelschreiber, Deutschland, Jan-Dez 2018

\* GfK Retail & Technology, GfK Panel market ballpoint pens, Germany, Jan-Dec 2018

”

**Nachhaltig denken.  
Verantwortungsvoll handeln.  
Schritt für Schritt.**

Thinking sustainably. Acting responsibly.  
Step by step.



**#theschneiderway**

[www.schneiderpen.com/nachhaltigkeit](http://www.schneiderpen.com/nachhaltigkeit)

[www.schneiderpen.com/sustainability](http://www.schneiderpen.com/sustainability)



## Gelebte Nachhaltigkeit Sustainability in practice



Unser Zuhause ist der Schwarzwald und der Harz. Diese unmittelbare Nähe zur Natur ist der Grund, warum Nachhaltigkeit so tief in unserer Unternehmensphilosophie verwurzelt ist. Sie leitet uns wie ein Kompass bei allen Entscheidungen, die wir treffen. Ressourcenschonung, Klimaschutz, Abfallvermeidung, Energieeffizienz und die ausschließliche Verwendung erneuerbarer Energien sind nur einige der vielen Beispiele für die durchgehend gelebte Nachhaltigkeitsorientierung. Im Zuge der konsequenten Zertifizierung nach dem Umweltmanagementsystem der EU (EMAS) wurden durch Investitionen in allen Bereichen CO<sub>2</sub>-Emissionen konsequent reduziert. Und unsere Produkte? Auch sie werden stetig ressourcenschonender und umweltfreundlicher. Und das sind nur einzelne, ausgewählte Schritte auf unserem Weg: #theschneiderway



Our home is the Black Forest and the Harz Mountains. Perhaps this closeness to nature is the reason why sustainability is so deeply rooted in our corporate philosophy. It guides us like a compass in all the decisions we make. Saving resources, climate protection, avoiding waste, energy efficiency and the exclusive use of renewable energy are just a few of the many examples of how we practice sustainability throughout the company. In the course of the ongoing, consistent certification according to the EU's environmental management system (EMAS), CO<sub>2</sub> emissions have been continuously reduced. What about our products? Our products are also constantly becoming more resource-efficient and environmentally friendly. And these are just individual, selected steps on our way: #theschneiderway

\* Schon gewusst? Alle Werbeschreibgeräte in diesem Katalog werden klimaneutral hergestellt.  
Did you know? All promotional writing instruments in this catalogue are produced in a climate-neutral manner.

## Regionale Verantwortung als Global Player Regional responsibility as a global player



Das bewahren, was einem viel bedeutet: Als inhabergeführtes, mittelständisches Familienunternehmen in dritter Generation übernehmen wir aus Überzeugung Verantwortung für die Regionen, in denen wir tätig sind. Die enge Verbundenheit zu unseren Produktionsstandorten im Schwarzwald und im Harz ist es, die uns antreibt, Flächenverbrauch, Verkehr und Emissionen zu reduzieren und uns darüber hinaus für den Gewässerschutz einzusetzen. Dabei arbeiten wir jeden Tag daran, ökologische Verträglichkeit, soziale Gerechtigkeit und wirtschaftliche Leistungsfähigkeit miteinander in Einklang zu halten. Als umsatzstarker Global Player nutzen wir damit unsere Chance, der Natur und der Gesellschaft etwas zurückgeben zu können.



Preserving what means a lot to you: As an owner-managed, medium-sized family business in its third generation, we take responsibility for the regions in which we operate out of conviction. The close ties to our production sites in the Black Forest and the Harz Mountains drive us to reduce land consumption, traffic and emissions, and also to work for water protection. In doing so, we work every day to reconcile ecological compatibility, social justice and economic performance. As a global player with a strong turnover, we are using this as an opportunity to give something back to nature and society.

# Nachhaltige Produkte

## Sustainable Products



[www.blauer-engel.de/uz200](http://www.blauer-engel.de/uz200)

### Blauer Engel Blue Angel

Der Blaue Engel ist seit über 40 Jahren das Umweltzeichen der Bundesregierung. Unabhängig und glaubwürdig setzt er anspruchsvolle Maßstäbe für umweltfreundliche Produkte und Dienstleistungen. Das Siegel gibt Behörden, gewerblichen Entscheidern, der freien Wirtschaft und privaten Konsumenten Orientierung beim nachhaltigen Einkauf. Wussten Sie, dass Schneider das erste Unternehmen war, das die strengen Richtlinien des Blauen Engels für Schreibgeräte erfüllte?

The "Blue Angel" has been the environmental label of the German Federal Government for 40 years. As an independent and credible organisation, it sets demanding standards for environmentally friendly products and services. The label provides orientation for sustainable purchasing for public authorities, commercial decision-makers, independent businesses and private consumers. Did you know that Schneider was the first company to meet the strict guidelines of the Blue Angel for writing instruments?



### Biobasierter Kunststoff Bio-based plastics

Als biobasiert werden Kunststoffe bezeichnet, die auf Basis nachwachsender Rohstoffe erzeugt werden. Als Ausgangsmaterial können dafür zum Beispiel Stärke aus Mais, Zucker aus Zuckerrohr und Zuckerrüben, Pflanzenöle wie Rizinusöl oder auch Cellulose aus Baumwolle oder Holz zum Einsatz kommen. Als neutraler und unabhängiger Dritter dokumentiert DIN CERTCO unseren ressourcenschonenden Rohstoffeinsatz und weist darüber hinaus den Anteil an biobasiertem Kunststoff nach.

Biobased plastics are produced on the basis of renewable raw materials. For example, starch from corn, sugar from sugar cane and sugar beet, vegetable oils such as castor oil or cellulose from cotton or wood can be used as raw materials. As a neutral and independent third party, DIN CERTCO documents our resource-saving use of raw materials and also certifies the proportion of biobased plastics.





## Recycling-Kunststoff Recycled plastics

PET-Flaschen, Elektrogeräte oder Abfall aus dem gelben Sack: Recycling-Kunststoffe haben schon ein „erstes Leben“ als Produkt hinter sich. Durch den Einsatz von Recyclat helfen wir aktiv mit, die immer knapper werdenden Rohstoff- und Energiequellen zu schonen und schädliches CO<sub>2</sub> einzusparen. Vertrauenswürdige und unabhängige Institutionen wie DIN CERTCO oder EuCertPlast belegen in Form von Zertifizierungen auf transparente Weise unsere Aussagen zur Verwendung von Recyclaten.

PET bottles, electrical appliances or waste from private households: Recycled plastics already had their "first life" as a product in the past. By using recycled materials, we are actively helping to conserve increasingly scarce sources of raw materials and energy and avoid harmful CO<sub>2</sub> emissions. Credible and independent institutions such as DIN CERTCO or EuCertPlast provide certifications as transparent proof of our statements concerning the use of recycled materials.



EuCertPlast



## Klimaneutrale Herstellung Climate neutral production

So geht klimaneutrale Herstellung bei Schneider: Zusammen mit ClimatePartner haben wir den ökologischen Fußabdruck (Corporate Carbon Footprint) unserer Produktionsstandorte berechnet und Maßnahmen ergriffen, um diesen so weit wie möglich zu reduzieren. Die bei der Herstellung unserer Produkte noch anfallenden, unvermeidbaren Emissionen (Product Carbon Footprint) haben wir ebenfalls berechnet und kompensieren diese durch Investitionen in zertifizierte internationale Klimaschutzprojekte.

Alle Produkte in diesem Katalog werden komplett klimaneutral hergestellt.

This is how climate neutral production at Schneider works: In conjunction with ClimatePartner, Schneider has computed the carbon footprint for the entire company and all facilities and has taken measures to reduce carbon emissions as much as possible. We have also calculated the unavoidable emissions (product carbon footprint) that still occur during the manufacture of our products and we offset these by investing in certified international climate protection projects.

All promotional writing instruments in this catalogue are produced in a climate-neutral manner.



ClimatePartner.com/53739-2110-1001

# Soft Touch

---

Samtige Oberfläche,  
exzellenter Griff: Mit der  
Soft Touch-Lackierung  
liegen Schreibgeräte  
besonders angenehm in  
der Hand.

A velvety touch, excellent grip: The  
Soft Touch finish makes writing in-  
struments especially comfortable to  
hold.

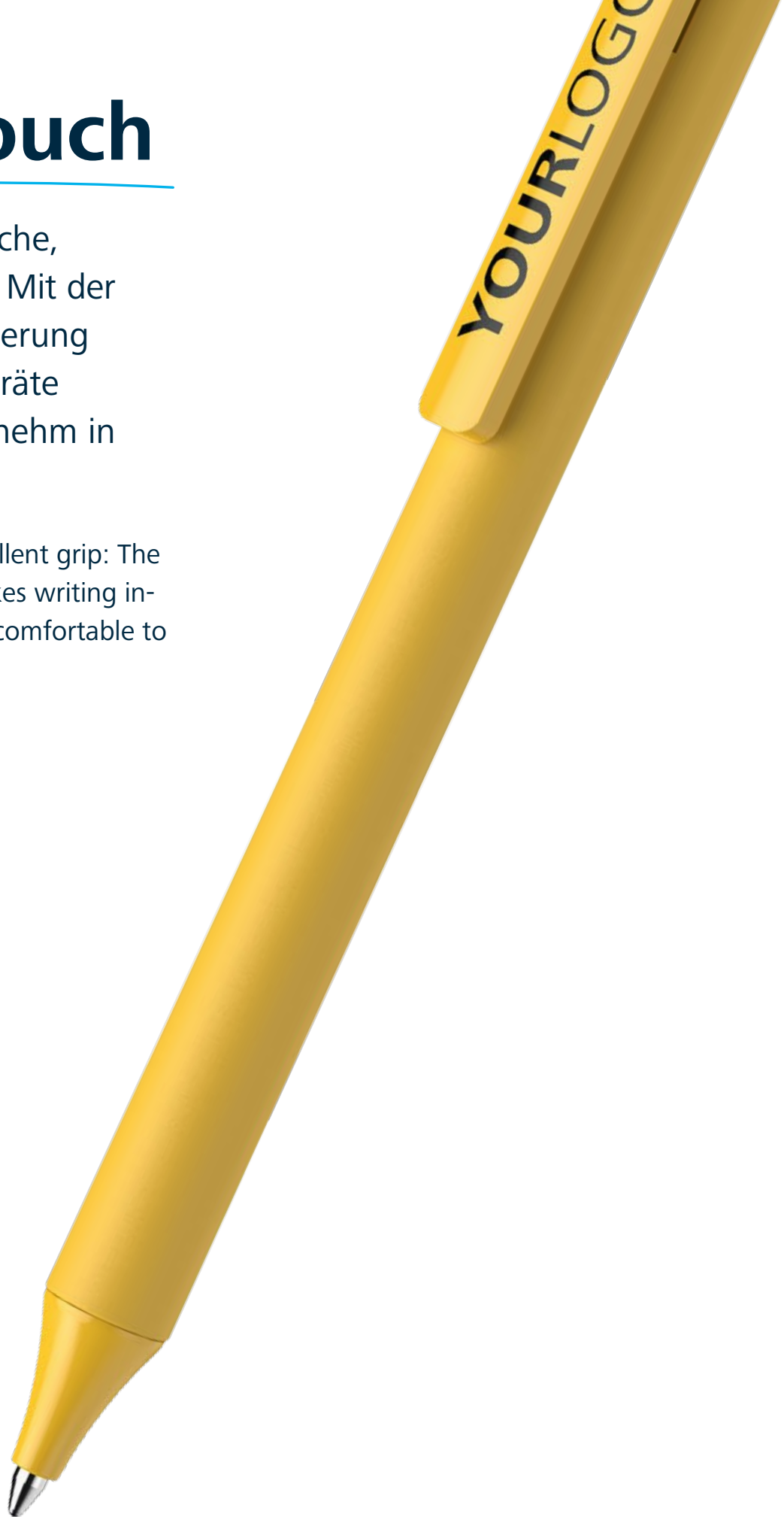

# Mix & Match

---

Alles andere als eintönig: Mit dem ausgeklügelten Prinzip Mix & Match können je nach Modell mehrere Farben beliebig miteinander kombiniert werden.

Anything but monotonous: With the ingenious "Mix & Match" principle, several colours can be combined with each other.



# Druckverfahren

## Printing techniques

### Siebdruck Screen printing

Hohe Farbschichtdicke zum günstigen Preis: Der Siebdruck gehört zu den Klassikern unter den Druckverfahren, insbesondere für Schaftdrucke.

High ink coverage, low price: Screen printing is one of the classic printing processes, especially for printing on the barrel.



### Tampondruck Pad printing

Die präzise Veredelung von konvexen oder konkaven Flächen ist dank des flexiblen Silikontampons ein Leichtes.

Precise finishing of convex or concave surfaces such as clips is easy thanks to the flexible silicone pad.

### Digitaldruck Digital printing

Bilder und Farbverläufe lassen sich mit diesem hochauflösenden Verfahren problemlos aufbringen – auch umsetzbar als erhabener, fühlbarer Druck.

Images and colour transitions can be easily applied with this high-resolution process – also possible as a tactile spot effect.





## Folientransfer Film transfer printing

Mithilfe des Folientransferdrucks können ganze Bildwelten rund um das Gehäuse gedruckt werden – für die perfekte Inszenierung Ihrer Marke.

Using film transfer printing, entire images can be printed around the barrel – for the perfect presentation of your brand.

## Gravur Engraving

Die Königin unter den Veredelungen verleiht Schreibgeräten ein ganz besonderes Finish – ebenso filigran wie exklusiv.

The queen of finishing gives writing instruments a very special look – it is as delicate as it is exclusive.



## Kunststofffarben Colours of the plastic material

Schwarz / Black 10	Silber / Silver 11	Pantone Cool Gray 6 12	Pantone Cool Gray 11 13	Pantone 432 14	Pantone Cool Gray 1 15	Pantone 429 16	Pantone 179 21
Pantone 187 24	Pantone 186 25	Pantone 296 27	Pantone 7694 30	Pantone 7687 31	Pantone 2756 32	Pantone 297 33	Pantone 293 34
Pantone 662 35	Pantone 311 36	Pantone 7468 37	Pantone 298 38	Pantone 315 39	Pantone 342 40	Pantone 327 41	Pantone 3425 42
Pantone 347 43	Pantone 355 44	Pantone 361 47	Pantone 368 48	Pantone Yellow 50	Pantone 116 51	Pantone 130 52	Pantone 123 53
Pantone 809 54	Pantone 1255 56	Pantone 151 62	Pantone 811 63	Pantone 1585 64	Pantone 158 65	Pantone 7594 68	Pantone 7588 69
Weiß / White 70	Glasklar / Transparent 71	Pantone 806 90	Pantone 214 93	Pantone 237 95	Pantone 248 96	Pantone 259 97	Pantone 258 98

# Produkte

## Products

- 1 Preiskategorie € / Price Category €
- 2 Preiskategorie €€ / Price Category €€
- 3 Preiskategorie €€€ / Price Category €€€
- 4 Preiskategorie €€€€ / Price Category €€€€



- 2 30 Reco (Variante/model „Basic“)
- 2 32 Reco (Variante/model „Line“)
- 2 34 Reco (Variante/model „Max“)
- 2 36 Slider Xite Promo
- 3 38 Slider Rave
- 2 40 Slider Memo XB
- 1 42 Slider Edge
- 1 44 Slider Basic XB
- 2 3 46 Link-It Slider
- 2 48 Take 4 Promo
- 3 50 Epsilon
- 3 52 Epsilon Touch
- 1 54 Like (opak/opaque)
- 1 56 Like (transparent)
- 1 58 Dynamix
- 1 60 Dynamix Recycling (opak/opaque)
- 1 62 Dynamix Recycling (transparent)
- 1 64 Dynamix Pro+
- 2 66 Dynamix Pro+ Soft Touch
- 1 68 Essential
- 1 70 Essential Soft Touch
- 1 72 Evo
- 1 74 Evo Recycling
- 1 76 Evo Pro
- 1 78 Evo Pro Recycling
- 2 80 Evo Pro Soft Touch
- 2 82 Evo Pro+
- 2 84 Haptify
- 2 86 Haptify Promo
- 1 88 K 1
- 1 90 K 1 Metal
- 1 92 K 1 Biosafe
- 1 94 Loox
- 1 96 Loox Promo
- 1 98 Loox Metal
- 1 100 K 15
- 1 102 Frosty
- 1 104 Office
- 1 106 Sunlite
- 1 108 Tops Promo





110  
**Universal-  
 Halterung**  
 Universal Holders

- 2 114 Klick-Fix-Pen Promo
- 1 116 Klick-Fix



138  
**Fineliner**  
 Fineliners

- 2 3 142 Link-It Fineliner
- 1 3 144 Line-Up
- 1 146 Topliner 963 Recycling
- 1 148 Topliner 967 Recycling



118  
**Textmarker**  
 Highlighters

- 2 3 122 Link-It Highlighter
- 1 124 Highlighter 180
- 1 126 Highlighter 150
- 1 128 Highlighter 177



150  
**Füller &  
 Tintenroller**  
 Fountain Pens &  
 Rollerballs

- 4 154 Ray Füller / Fountain pen
- 4 156 Ray Tintenroller / Rollerball
- 2 158 One Business
- 1 160 Topball 863 Recycling
- 1 162 Topball 857 Recycling



130  
**Permanent  
 Marker**  
 Permanent Markers

- 1 134 Permanent Marker 130
- 1 136 Universal Marker 224



”

**Kugelschreiber sind langlebig,  
praktisch und vielseitig –  
„Made in Germany“ und ein  
nachhaltiges Konzept machen  
sie zum Qualitätsprodukt.**

Ballpoint pens are long-lasting, convenient  
and versatile – "Made in Germany" and a  
sustainable concept turn them into a quality product.

# Kugelschreiber

Ballpoint Pens





# Kugelschreiber

## Ballpoint Pens



Soft Touch



Mix & Match



Biobasierter Kunststoff / Bio-based plastics



Recycling-Kunststoff / Recycled plastics



Preiskategorie € / Price Category €



Preiskategorie €€ / Price Category €€



Preiskategorie €€€ / Price Category €€€



Preiskategorie €€€€ / Price Category €€€€



30 Reco



2



Bio

2



54 Like (opak/opaque)

1



56 Like (transparent)

1



74 Evo Recycling



1



76 Evo Pro

1



94 Loox

1



96 Loox Promo

1





98 Loox Metal  
1  
Mix & Match



100 K 15  
1  
Mix & Match



102 Frosty  
1  
Mix & Match



104 Office  
1  
Mix & Match



106 Sunlite  
1  
Mix & Match



108 Tops Promo  
1



78 Evo Pro Recycling  
1  
Bio



80 Evo Pro Soft Touch  
2  
Mix & Match



82 Evo Pro+  
2



84 Haptify  
2  
Mix & Match



86 Haptify Promo  
2  
Mix & Match



88 K 1  
1  
Mix & Match



90 K 1 Metal  
1



92 K 1 Biosafe  
1  
Bio



58 Dynamix  
1  
Mix & Match



60 Dynamix Recycling (opak/opaque)  
1  
Bio  
Mix & Match



62 Dynamix Recycling (transparent)  
1  
Bio  
Mix & Match



64 Dynamix Pro+  
1  
Mix & Match



66 Dynamix Pro+ Soft Touch  
2  
Mix & Match



68 Essential  
1  
Mix & Match



70 Essential Soft Touch  
1  
Mix & Match



72 Evo  
1  
Mix & Match



38 Slider Rave  
3  
Mix & Match



40 Slider Memo XB  
2  
Mix & Match



42 Slider Edge XB  
1  
Mix & Match



44 Slider Basic XB  
1



46 Link-It Slider  
2  
3  
Bio  
Mix & Match



48 Take 4 Promo  
2  
Bio



50 Epsilon  
3



52 Epsilon Touch  
3



# Die gute Schneider Mine

---

The "good Schneider refill"

Mit dem Werbeslogan „Die gute Schneider Mine“ waren die Kugelschreiberminen von Schneider in den 1950er und 60er Jahren in aller Munde. Eine leere Mine problemlos austauschen: Damals war das eine Neuheit; bewährt hat sich das Konzept bis heute. Ausgezeichnete Qualität „Made in Germany“ sowie ständige Innovationen, wie beispielsweise die Viscoglide®-Technologie, verlängern die Gebrauchsdauer eines Schreibgeräts im Handumdrehen – ein kleines Investment in eine nachhaltigere Zukunft für alle.



Everybody was talking about Schneider ballpoint pen refills in the 1950s and 60s when the company's advertising slogan was "The good Schneider refill". To replace an empty refill: At that time, this was a new development; however, the concept has remained successful until today. Excellent "Made in Germany" quality and constant innovations, such as Viscoglide® technology, extend the service life of a writing instrument in the blink of an eye – a small investment for a more sustainable future for everyone.

# Highlight-Tipp: die nachhaltige Eco 725 M

## Product highlight: the sustainable Eco 725 M



[www.blauer-engel.de/uz200](http://www.blauer-engel.de/uz200)

### ausgezeichnet mit dem Blauen Engel

certified with the "Blue Angel" eco-label

Die Mine Eco 725 M mit einem Gehäuse aus 95% Recycling-Kunststoff ist die erste Kugelschreiber-Mine überhaupt, die zusammen mit dem Kugelschreiber Reco mit dem renommierten Umweltzeichen "Blauer Engel" ausgezeichnet wurde.

The refill Eco 725 M with a barrel made of 95% recycled plastic is the first ballpoint pen refill ever to be awarded the prestigious "Blue Angel" eco-label alongside the ballpoint pen Reco.

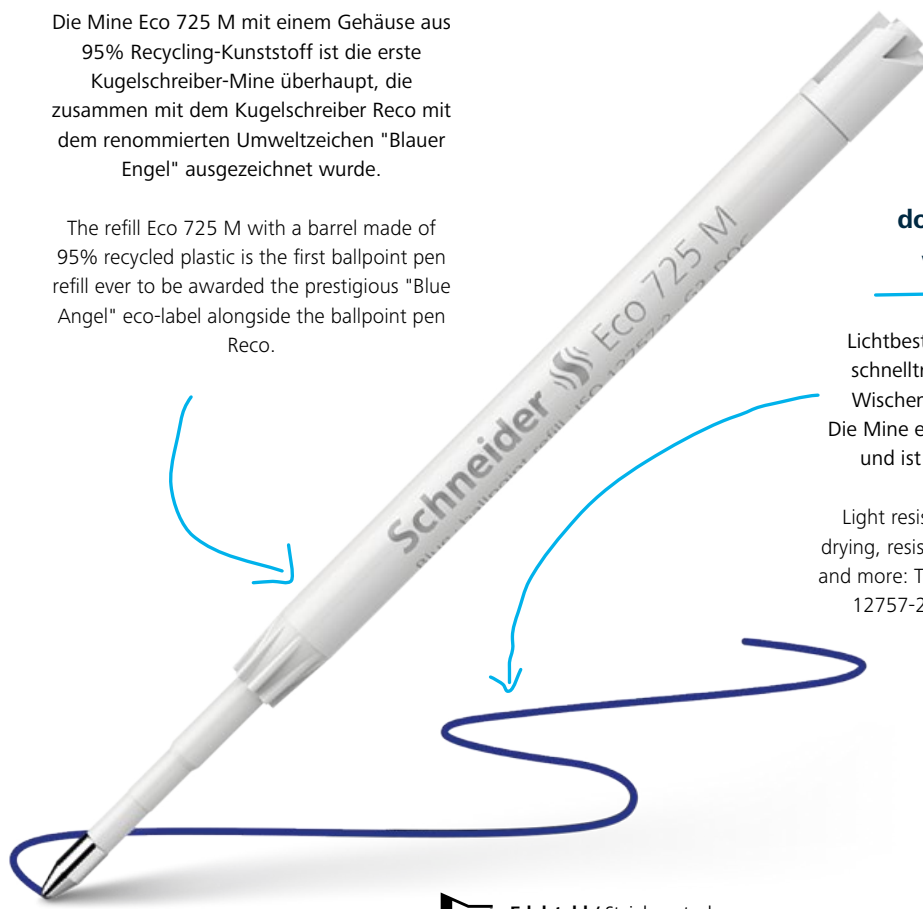

### dokumentenecht

waterproof ink

Lichtbeständig, wassertropfenfest, schnelltrocknend, resistent gegen Wischen und Radieren und mehr: Die Mine erfüllt die Norm ISO 12757-2 und ist damit dokumentenecht.

Light resistant, water resistant, quick drying, resistant to smudging and erasing and more: The refill complies with the ISO 12757-2 standard and is therefore waterproof.



### dauerhaft sauberes Schriftbild

permanently clean writing

Schmierer oder klecksen? Mit Qualität von Schneider kein Thema mehr. Die hochpräzise, verschleißfeste Edelstahlspitze und die darauf abgestimmte Paste sorgen für ein angenehmes und sauberes Schriftbild.

Smearing and smudging? No longer an issue with quality made by Schneider. The high-precision, wear-resistant stainless steel tip and the matching ink paste ensure comfortable and clean writing.



extralange Schreibdauer / extra long writing endurance

# Pasten-Minen



Refills with ink paste



## Express 735 M

**Strichstärke / Line width:** M / M

**Dokumentenecht / Waterproof ink:**

nach ISO 12757-2 / according to ink standard ISO 12757-2

**Farben / Colours:**



Unser Kugelschreiberminen-Klassiker in Metall für maximale Schreibleistung! Premium-Großraummine im ISO-Format G2. Die verschleißfeste Edelstahlspitze garantiert, dass der große Pastenvorrat vollständig und schmierfrei genutzt werden kann.

Our classic metal ballpoint pen refills for maximum writing performance! Premium giant refill in ISO-Format G2. The wear-resistant stainless steel tip guarantees that the large paste supply can be used completely and without smearing.



## Express 739 M

**Strichstärke / Line width:** M / M

**Dokumentenecht / Waterproof ink:**

nach ISO 12757-2 / according to ink standard ISO 12757-2

**Farben / Colours:**



Unser Kugelschreiberminen-Klassiker in einem Kunststoffgehäuse. Großraummine im ISO-Format G2. Die verschleißfeste Edelstahlspitze garantiert, dass der große Pastenvorrat vollständig und schmierfrei genutzt werden kann.

Our classic ballpoint pen refill with a plastic barrel. Giant refill in ISO-Format G2. The wear-resistant stainless steel tip guarantees that the large paste supply can be used completely and without smearing.



## Express 775 M

**Strichstärke / Line width:** M / M

**Dokumentenecht / Waterproof ink:**

nach ISO 12757-2 / according to ink standard ISO 12757-2

**Farben / Colours:**



Unsere Premium-Mine aus Metall im X20-Format. Die verschleißfeste Edelstahlspitze garantiert, dass der Pastenvorrat vollständig und schmierfrei genutzt werden kann.

Our premium metal refill in X20 format. The wear-resistant stainless steel tip guarantees that the large paste supply can be used completely and without smearing.





## 774 M

**Strichstärke / Line width:** M / M

**Dokumentenecht / Waterproof ink:**

nach ISO 12757-2 / according to ink standard ISO 12757-2

**Farben / Colours:**



Unsere Economy-Lösung für dauerhaft saubere Schrift. Kunststoffmine im Format X20. Die verschleißfeste Edelstahlspitze garantiert, dass der Pastenvorrat vollständig und schmierfrei genutzt werden kann.

Our Economy Class for durable, clean writing. Plastic refill in X20 format. The wear-resistant stainless steel tip guarantees that the large paste supply can be used completely and without smearing.



[www.blauer-engel.de/uz200](http://www.blauer-engel.de/uz200)



## Eco 725 M

**Strichstärke / Line width:** M / M

**Dokumentenecht / Waterproof ink:**

nach ISO 12757-2 / according to ink standard ISO 12757-2

**Farben / Colours:**



Unser ausgezeichnete Kugelschreiberminen-Klassiker! Großraummine im ISO-Format G2 mit einem ressourcenschonenden Gehäuse aus 95% recyceltem Kunststoff. Die verschleißfeste Edelstahlspitze garantiert, dass der große Pastenvorrat vollständig und schmierfrei genutzt werden kann.

Our award-winning ballpoint pen refill classic! Giant refill in ISO-Format G2 with pen body made from 95% recycled plastic. The wear-resistant stainless steel tip guarantees that the large paste supply can be used completely and without smearing.

Gehäuse besteht zu 95% aus recyceltem Kunststoff /  
Barrel is made of 95% recycled plastic



## 770 M

**Strichstärke / Line width:** M / M

**Dokumentenecht / Waterproof ink:**

nach ISO 12757-2 / according to ink standard ISO 12757-2

**Farben / Colours:**



Unsere Economy-Lösung für saubere Schrift. Kunststoffmine im Format X20.

Our Economy Class for durable, clean writing. Plastic refill in X20 format.

fließend-seidiges Schreibgefühl / fluid silky writing experience

# Viscoglide®-Minen



## Viscoglide®-refills



### Slider 755 M

**Strichstärke / Line width:** M / M

**Dokumentenecht / Waterproof ink:**

nach ISO 12757-2 (außer Schreibfarbe rot) /  
according to ink standard ISO 12757-2 (except for writing colour red)

**Farben / Colours:**



Unser Remix des Kugelschreiberminen-Klassikers im Großraumformat! Premium-Metallmine mit innovativer Tintenmischung für außergewöhnlich weiches und gleitendes Schreiben. Die verschleißfeste Edelstahlspitze garantiert, dass der große Pastenvorrat vollständig und schmierfrei genutzt werden kann.

Our remix of the classic ballpoint pen refills with a large format! Premium metal refill with innovative ink mixture for exceptionally smooth and gliding writing. The wear-resistant stainless steel tip guarantees that the large paste supply can be used completely and without smearing.



### Slider 755 XB\*

**Strichstärke / Line width:** XB / XB

**Dokumentenecht / Waterproof ink:**

nach ISO 12757-2 (außer Schreibfarbe rot) /  
according to ink standard ISO 12757-2 (except for writing colour red)

**Farben / Colours:**



Unser Remix des Kugelschreiberminen-Klassikers im Großraumformat! Premium-Metallmine mit innovativer Tintenmischung für außergewöhnlich weiches und gleitendes Schreiben. Die verschleißfeste Edelstahlspitze garantiert, dass der große Pastenvorrat vollständig und schmierfrei genutzt werden kann.

Our remix of the classic ballpoint pen refills with a large format! Premium metal refill with innovative ink mixture for exceptionally smooth and gliding writing. The wear-resistant stainless steel tip guarantees that the large paste supply can be used completely and without smearing.



### Slider 710 XB\*

**Strichstärke / Line width:** XB / XB

**Dokumentenecht / Waterproof ink:**

nach ISO 12757-2 (außer Schreibfarbe rot) /  
according to ink standard ISO 12757-2 (except for writing colour red)

**Farben / Colours:**



Unsere Premium-Metallmine mit innovativer Tintenmischung für außergewöhnlich weiches und gleitendes Schreiben. Format X20. Die verschleißfeste Edelstahlspitze garantiert, dass der Pastenvorrat vollständig und schmierfrei genutzt werden kann.

Our premium metal refill with innovative ink mixture for exceptionally smooth and gliding writing. Format X20. The wear-resistant stainless steel tip guarantees that the large paste supply can be used completely and without smearing.

\* extrabreite Strichstärke (XB) / extra broad line width (XB)



778 XB\*

Unsere Economy-Lösung mit innovativer Tintenmischung für außergewöhnlich weiches und gleitendes Schreiben. Die verschleißfeste Edelstahlspitze garantiert, dass der Pastenvorrat vollständig und schmierfrei genutzt werden kann.

Our Economy Class with innovative ink mixture for exceptionally smooth and gliding writing. The wear-resistant stainless steel tip guarantees that the large paste supply can be used completely and without smearing.

**Strichstärke / Line width:** XB / XB

**Dokumentenecht / Waterproof ink:**

nach ISO 12757-2 / according to ink standard ISO 12757-2

**Farben / Colours:** schwarz, blau / black, blue



**Strichstärke / Line width:** M / M

**Dokumentenecht / Waterproof ink:**

nach ISO 12757-2 / according to ink standard ISO 12757-2

**Farben / Colours:**



## Take 4 Refill

Nachfüllstoff für unseren Vierfarbkugelschreiber Take 4 Promo! Mit Viscoglide®-Technologie für sensationell weiches und gleitendes Schreiben.

Refills for our four-colour ballpoint pen Take 4 Promo! Viscoglide® technology for extraordinarily smooth and gliding writing.

*extrasmoothes Schreibgefühl / extra-smooth writing sensation*

# Gel-Mine



## Gel-refills



## Gelion+

Unser Großraumminen-Klassiker mit innovativer Geltinte! Gelmine im ISO-Format G2 für das ultimative Gel-Schreiberlebnis. Das neue High Performance Gel überzeugt durch ein extrem leichtes und flüssiges Schreibgefühl. Die ultra schnelltrocknende Tinte verhindert ein Verwischen der Schrift und ist somit auch für Linkshänder geeignet.

Our classic giant refill with innovative gel ink! ISO format G2 gel refill for the ultimate gel writing experience. The new High Performance Gel convinces with an extremely light and fluid writing sensation. The ultra fast-drying ink prevents smudging and is therefore also perfectly suitable for left-handers.

**Strichstärke / Line width:** 0,4mm

**Dokumentenecht / Waterproof ink:**

Schwarz ist dokumentenecht nach ISO 27668-2 /

Black is waterproof according to ink standard ISO 27668-2

**Farben / Colours:**



*neue, innovative Formel für längere Haltbarkeit /  
new, innovative formula for longer shelf life*

# Inspiration

---

## Inspiration



60 Dynamix Recycling (opak / opaque)



68 Essential



76 Evo Pro



84 Haptify



54 Like (opak / opaque)



96 Loox Promo



34 Reco (Variante / model "Max")



32 Reco (Variante / model "Line")



48 Take 4 Promo



38 Slider Rave



42 Slider Edge



[www.blauer-engel.de/uz200](http://www.blauer-engel.de/uz200)



# Reco (Variante / model „Basic“)



Mine/Refill Eco 725 M

Erster Kugelschreiber, der mit dem weltweit bekanntesten Umweltzeichen "Blauer Engel" ausgezeichnet ist. Dynamisches Design mit elegant matt schimmernder Oberfläche. Auswechselbare Großraummine Eco 725 M mit einem Gehäuse aus 95 % recyceltem Kunststoff.

First ballpoint pen in the world that has been awarded the most famous eco-label "Blue Angel". Dynamic design with elegant matt satin surface. Replaceable giant refill Eco 725 M with barrel made of 95% recycled plastic.

*\*Gehäuse aus 92 % recyceltem Kunststoff. Klimaneutral hergestellt.  
\*Pen body made of 92% recycled plastic. Produced climate neutrally.*



EuCertPlast

# Mix & Match

Mit dem ausgeklügelten Prinzip Mix & Match können mehrere Farben miteinander kombiniert werden.  
With the ingenious "Mix & Match" principle, several colours can be combined with each other.



## Farben Colours

### Verfügbar ab /

Available from:

Bestell-Nr. / Ref. No.:

≥300 St. / pcs.

931799 (ohne Aufdruck „Blauer Engel“ / without imprint "Blue Angel")

931789 (mit Aufdruck „Blauer Engel“ / with imprint "Blue Angel")

### Farbauswahl / Select colour:

Druckknopf (Einsatz in Schafffarbe) /  
Push button (application in barrel colour)



Schaftverlängerung /  
Barrel extension

Clip 1:

Clip ohne Rille (bedruckbar) /  
Ungrooved clip (imprintable)



2:

Clip mit Rille (nicht bedruckbar) /  
Grooved clip (not imprintable)

Schaft / Barrel

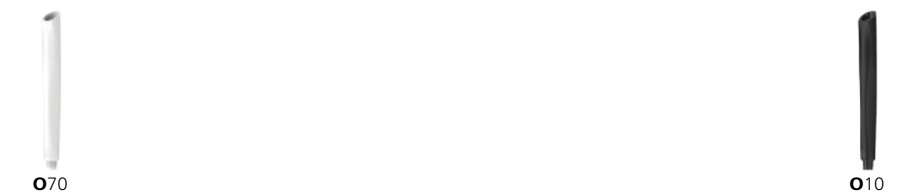

Spitze / Tip



Sondergehäusefarbe auf Anfrage / Special colours for pen body upon request

Mindestmenge / Minimum quantity: ≥10.000 St. / pcs.

Bestell-Nr. / Ref. No.: 931799 (ohne Aufdruck „Blauer Engel“ / without imprint "Blue Angel"), 931789 (mit Aufdruck „Blauer Engel“ / with imprint "Blue Angel")

## Druckflächen (in mm) Imprint positions (in mm)

### Siebdruck / Screen printing

### Tampondruck / Pad printing

T4: 40 × 3 (6), T6: 50 × 7, T8: 31 × 3, T19.1/T19.2: 27 × 7,  
T29.1/T29.2: 59 × 8

### Digitaldruck / Digital printing

### Filmtransfer / Film transfer printing

### Gravur / Engraving





[www.blauer-engel.de/uz200](http://www.blauer-engel.de/uz200)



# Reco (Variante / model „Line“)



Mine/Refill Eco 725 M

Erster Kugelschreiber, der mit dem weltweit bekanntesten Umweltzeichen "Blauer Engel" ausgezeichnet ist. Dynamisches Design mit elegant matt schimmernder Oberfläche. Variante „Line“ mit farbiger Designlinie. Auswechselbare Großraummine Eco 725 M mit einem Gehäuse aus 95 % recyceltem Kunststoff.

First ballpoint pen in the world that has been awarded the most famous eco-label "Blue Angel". Dynamic design with elegant matt satin surface. Model "Line" with coloured line. Replaceable giant refill Eco 725 M with barrel made of 95% recycled plastic.

*\*Gehäuse aus 92 % recyceltem Kunststoff. Klimaneutral hergestellt.  
\*Pen body made of 92% recycled plastic. Produced climate neutrally.*



EuCertPlast



## Mix & Match

Mit dem ausgeklügelten Prinzip Mix & Match können mehrere Farben miteinander kombiniert werden.  
With the ingenious "Mix & Match" principle, several colours can be combined with each other.



## Farben Colours

Verfügbar ab /  
Available from:

Bestell-Nr. / Ref. No.:

≥300 St. / pcs.

931599 (ohne Aufdruck „Blauer Engel“ / without imprint "Blue Angel")

931589 (mit Aufdruck „Blauer Engel“ / with imprint "Blue Angel")

Farbauswahl / Select colour:

Druckknopf (Einsatz in Schafffarbe) /  
Push button (application in barrel colour)



Schaftverlängerung /  
Barrel extension

Clip 1:  
Clip ohne Rille (bedruckbar) /  
Ungrooved clip (imprintable)



Schaft / Barrel



Spitze / Tip

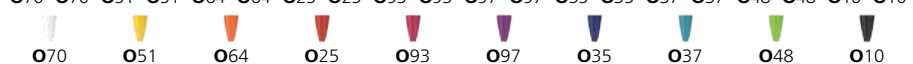

Sondergehäusefarbe auf Anfrage / Special colours for pen body upon request

Mindestmenge / Minimum quantity: ≥10.000 St. / pcs.

Bestell-Nr. / Ref. No.: 931599 (ohne Aufdruck „Blauer Engel“ / without imprint "Blue Angel"), 931589 (mit Aufdruck „Blauer Engel“ / with imprint "Blue Angel")

## Druckflächen (in mm) Imprint positions (in mm)

Siebdruck / Screen printing

Tampondruck / Pad printing

T4: 40 × 3 (6), T6: 50 × 7, T8: 31 × 2,5, T19.1/T19.2: 27 × 6,  
T29.1/T29.2: 59 × 7

Digitaldruck / Digital printing

Filmtransfer / Film transfer printing

Gravur / Engraving

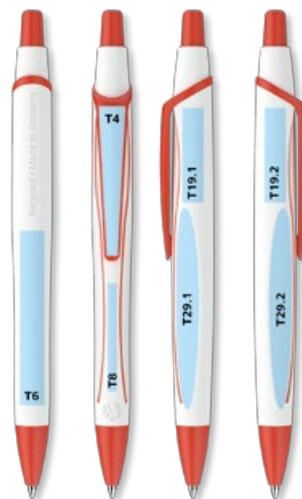



[www.blauer-engel.de/uz200](http://www.blauer-engel.de/uz200)



# Reco (Variante / model „Max“)



Mine/Refill Eco 725 M

Erster Kugelschreiber, der mit dem weltweit bekanntesten Umweltzeichen "Blauer Engel" ausgezeichnet ist. Dynamisches Design mit elegant matt schimmernder Oberfläche. Variante „Max“ mit größerer Druckfläche. Auswechselbare Großraummine Eco 725 M mit einem Gehäuse aus 95 % recyceltem Kunststoff.

First ballpoint pen in the world that has been awarded the most famous eco-label "Blue Angel". Dynamic design with elegant matt satin surface. Model "Max" with larger printing area. Replaceable giant refill Eco 725 M with barrel made of 95% recycled plastic.

*\*Gehäuse aus 92 % recyceltem Kunststoff. Klimaneutral hergestellt.  
\*Pen body made of 92% recycled plastic. Produced climate neutrally.*



EuCertPlast

## Mix & Match

Mit dem ausgeklügelten Prinzip Mix & Match können mehrere Farben miteinander kombiniert werden.  
With the ingenious "Mix & Match" principle, several colours can be combined with each other.



## Farben Colours

**Verfügbar ab /  
Available from:  
Bestell-Nr. / Ref. No.:**

≥ 300 St. / pcs.  
931399 (ohne Aufdruck „Blauer Engel“ / without imprint "Blue Angel")  
931389 (mit Aufdruck „Blauer Engel“ / with imprint "Blue Angel")

**Farbauswahl / Select colour:**

	O70	O51	O64	O25	O93	O97	O35	O37	O48	O10
Druckknopf (Einsatz in Schafffarbe) / Push button (application in barrel colour)										
Schaftverlängerung / Barrel extention										
Clip 3: Breiter Clip (bedruckbar) / Wide Clip (imprintable)										
Schaft / Barrel										
Spitze / Tip										

Sondergehäusefarbe auf Anfrage / Special colours for pen body upon request  
Mindestmenge / Minimum quantity: ≥ 10.000 St. / pcs.

Bestell-Nr. / Ref. No.: 931399 (ohne Aufdruck „Blauer Engel“ / without imprint "Blue Angel"), 931389 (mit Aufdruck „Blauer Engel“ / with imprint "Blue Angel")

## Druckflächen (in mm) Imprint positions (in mm)

**Siebdruck / Screen printing**

**Tampondruck / Pad printing**

T4.1: 40 × 5 (6,5), T4.2: 20 × 7,5, T6: 50 × 7, T8: 31 × 3, T19.1/T19.2: 50 × 6,  
T29.1/T29.2: 32 × 7

**Digitaldruck / Digital printing**

**Filmtransfer / Film transfer printing**

**Gravur / Engraving**



# Slider Xite Promo

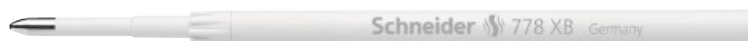

**Mine/Refill 778 XB**

Eine Bestückung mit anderer Mine ist auf Anfrage möglich.  
Can be equipped with other refills upon request.

Druckkugelschreiber mit weißem Gehäuse. Zierring und Schaftverlängerung farblich abgesetzt. Die Viscoglide®-Technologie sorgt für außergewöhnlich weiches und gleitendes Schreiben. Leicht konkav geformter Schaft und stabiler Metallclip. Ausgestattet mit Schneider-Mine 778 XB.

Ballpoint pen with white pen body. Decorative ring and barrel extension can clearly be distinguished in terms of colour. The Viscoglide® technology ensures extraordinarily smooth and gliding writing. Slightly concave-shaped barrel and sturdy metal clip. Equipped with Schneider refill 778 XB.

*\*Gehäuse aus 70% biobasiertem Kunststoff. Klimaneutral hergestellt.*

*\*Pen body made of 70% biobased plastics. Produced climate neutrally.*

# Inspiration



## Farben Colours

Verfügbar ab /  
Available from:

≥ 100 St. / pcs.  
933299

Bestell-Nr. / Ref. No.:

Farbauswahl / Select colour:

Metalldruckknopf mit Farbkennung /  
Metal push button with coloured detail



O70



O52



O25



O34



O38



O44



O10

Schaftverlängerung /  
Barrel extension



O70



O52



O25



O34



O38



O44



O10

Schaft /  
Barrel



O70

-

-

-

-

-

-

Zierring /  
Decorative ring



O70



O52



O25



O34



O38



O44



O10

Spitze /  
Tip



O70



-



-



-



-



-



-

Sondergehäusefarbe auf Anfrage / Special colours for pen body upon request  
Mindestmenge / Minimum quantity: ≥ 10.000 St. / pcs.  
Bestell-Nr. / Ref. No.: 933299

## Druckflächen (in mm) Imprint positions (in mm)

### Siebdruck / Screen printing

S2: 55 × 14, S8: 40 × 28

### Tampondruck / Pad printing

T4: 35 × 5

### Digitaldruck / Digital printing

—

### Filmtransfer / Film transfer printing

—

### Gravur / Engraving

G4: 38 × 5,5

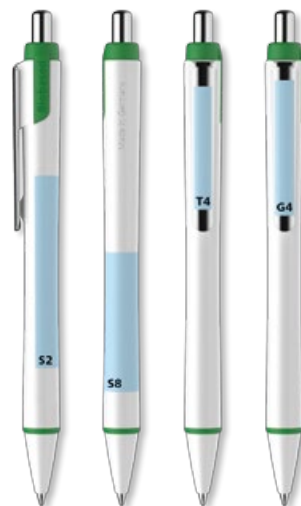

# Slider Rave



## Mine/Refill Slider 755 XB

Eine Bestückung mit anderer Mine ist auf Anfrage möglich.  
Can be equipped with other refills upon request.

Druckkugelschreiber mit Viscoglide®-Technologie für außergewöhnlich weiches und gleitendes Schreiben. Ergonomische Form mit gummierter Oberfläche. Clip und Spitze aus Metall. Ausgestattet mit Schneider-Metall-Großraummine Slider 755 XB.

Retractable ballpoint pen with Viscoglide® technology for extraordinarily smooth and gliding writing. Ergonomic form with rubberised surface. Metal clip and tip. Equipped with Schneider giant metal refill Slider 755 XB.

Klimaneutral hergestellt.

Produced climate neutrally.

# Inspiration



## Farben Colours

<b>Verfügbar ab / Available from:</b>	≥ 100	≥ 100	≥ 100	≥ 100	≥ 100	≥ 100	≥ 100	≥ 100	≥ 100
<b>St. / pcs.</b>	St. / pcs.	St. / pcs.	St. / pcs.	St. / pcs.	St. / pcs.	St. / pcs.	St. / pcs.	St. / pcs.	St. / pcs.
<b>Bestell-Nr. / Ref. No.:</b>	932501	932503	932581	932583	932582	932584	932586	932585	932599

**Farbauswahl /  
Select colour:**

Schaft / Barrel

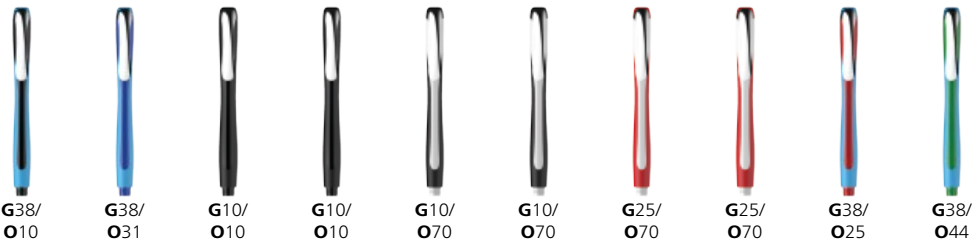

G38/O10 G38/O31 G10/O10 G10/O10 G10/O70 G10/O70 G25/O70 G25/O70 G38/O25 G38/O44

Mine / Refill:



Sondergehäusefarbe auf Anfrage / Special colours for pen body upon request  
Mindestmenge / Minimum quantity: ≥ 10.000 St. / pcs.  
Bestell-Nr. / Ref. No.: 932599

## Druckflächen (in mm) Imprint positions (in mm)

**Siebdruck / Screen printing**

—

**Tampondruck / Pad printing**

T4: 27 × 5, T7: 45 × 3,5, T8: 36 × 3,5

**Digitaldruck / Digital printing**

—

**Filmtransfer / Film transfer printing**

—

**Gravur / Engraving**

G4: 20 × 5



# Slider Memo XB



#### Schreibfarben/Writing colours

Folgende Sonderschreibfarben sind auf Anfrage erhältlich.  
The following special writing colours are available upon request.



Kappen-Kugelschreiber mit innovativer Viscoglide®-Technologie für außergewöhnlich weiches und gleitendes Schreiben. Ergonomische Form mit gummierter Oberfläche. Metallclip. Extrabreite (XB) verschleißfeste Schreibspitze aus Edelstahl.  
Capped ballpoint pen with innovative Viscoglide® technology for extraordinarily smooth and gliding writing. Ergonomic form with rubberised surface. Metal clip. Extra wide (XB) wear resistant writing tip in stainless steel.

Klimaneutral hergestellt.

Produced climate neutrally.



# Inspiration



## Farben Colours

Verfügbar ab / Available from: Bestell-Nr. / Ref. No.:	≥600 St. / pcs. 950282	≥600 St. / pcs. 950284	≥600 St. / pcs. 950281	≥600 St. / pcs. 950283	≥1.000 St. / pcs. 950206	≥1.000 St. / pcs. 950202	≥1.000 St. / pcs. 950209	≥1.000 St. / pcs. 950208	≥1.000 St. / pcs. 950203	≥1.000 St. / pcs. 950204	≥1.000 St. / pcs. 950201
Kappe / Cap											
Stopfen / Plug											
Schaft / Barrel											
	G10/ O70	G10/ O70	G10/ O10	G10/ O10	G38/ O64	G38/ O25	G38/ O93	G38/ O97	G38/ O31	G38/ O44	G38/ O10
Mine / Refill:	●	●	●	●	●	●	●	●	●	●	●

Sondergehäusefarbe auf Anfrage / Special colours for pen body upon request  
Mindestmenge / Minimum quantity: ≥10.000 St. / pcs.  
Bestell-Nr. / Ref. No.: 950299

## Druckflächen (in mm) Imprint positions (in mm)

Siebdruck / Screen printing

Tampondruck / Pad printing

T1: 45 × 3,5, T4: 24 × 5, T7: 45 × 3,5

Digitaldruck / Digital printing

Filmtransfer / Film transfer printing

Gravur / Engraving

G4: 20 × 6



# Slider Edge



## Schreibfarben / Writing colours

Folgende Sonderschreibfarben sind auf Anfrage erhältlich.  
The following special writing colours are available upon request.



Kugelschreiber mit Viscoglide®-Technologie für außergewöhnlich leichtes und gleitendes Schreiben. Der großzügig gummierte Dreikantschaft ermöglicht eine entspannte und sichere Schreibhaltung. Extrabreite (XB) verschleißfeste Schreibspitze aus Edelstahl.

Ballpoint pen with Viscoglide® technology for extraordinarily smooth and gliding writing. A generously rubberised three-sided barrel is designed for relaxed writing. Extra wide (XB) wear resistant writing tip in stainless steel.

























*Klimaneutral hergestellt.*

*Produced climate neutrally.*

# Inspiration



## Farben Colours

Verfügbar ab / Available from:	≥ 600 St. / pcs.	≥ 600 St. / pcs.	≥ 600 St. / pcs.	≥ 600 St. / pcs.	≥ 600 St. / pcs.	≥ 600 St. / pcs.
Bestell-Nr. / Ref. No.:	952201	952203	952281	952283	952282	952284
Kappe / Cap						
Stopfen / Plug						
Schaft / Barrel						
	<b>G38/ O10</b>	<b>G38/ O31</b>	<b>G10/ O10</b>	<b>G10/ O10</b>	<b>G10/ O70</b>	<b>G10/ O70</b>
Mine / Refill:						

Sondergehäusefarbe auf Anfrage / Special colours for pen body upon request  
Mindestmenge / Minimum quantity: ≥ 10.000 St. / pcs.  
Bestell-Nr. / Ref. No.: 952299

## Druckflächen (in mm) Imprint positions (in mm)

### Siebdruck / Screen printing

—

### Tampondruck / Pad printing

T1: 60 × 4,5

### Digitaldruck / Digital printing

D1: 69 × 5,5

### Filmtransfer / Film transfer printing

—

### Gravur / Engraving

—

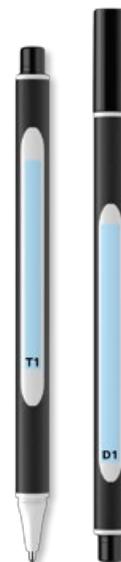

# Slider Basic XB



## Schreibfarben/Writing colours

Folgende Sonderschreibfarben sind auf Anfrage erhältlich.  
The following special writing colours are available upon request.



Kappen-Kugelschreiber mit Viscoglide®-Technologie für außergewöhnlich weiches und gleitendes Schreiben. Aus transparentem Kunststoff mit gummierter Griffzone. Extrabreite (XB) verschleißfeste Schreibspitze aus Edelstahl.  
Capped ballpoint pen with Viscoglide® technology for extraordinarily smooth, gliding writing. In transparent plastics with rubberised grip zone. Extra wide (XB) wear resistant writing tip in stainless steel.

*Klimaneutral hergestellt.  
Produced climate neutrally.*

# Inspiration



## Farben Colours

**Verfügbar ab /  
Available from:  
Bestell-Nr. / Ref. No.:**

≥ 1.000 St. / pcs.  
951201

≥ 1.000 St. / pcs.  
951203

Kappe /  
Cap



T71/O10

T71/O34

Stopfen /  
Plug



O10

O34

Schaft mit Griffzone /  
Barrel with rubber grip section



T71/G10

T71/G34

Spitze /  
Tip



O10

O34

Mine / Refill:



Sondergehäusefarbe auf Anfrage / Special colours for pen body upon request  
Mindestmenge / Minimum quantity: ≥ 10.000 St. / pcs.  
Bestell-Nr. / Ref. No.: 951299

## Druckflächen (in mm) Imprint positions (in mm)

### Siebdruck / Screen printing

S1: 65 × 24 (1C)

### Tampondruck / Pad printing

T4: 32 × 4,5

### Digitaldruck / Digital printing

### Filmtransfer / Film transfer printing

F1: 76, 360° (≥ 10.000)

### Gravur / Engraving



# Link-It Slider



Schreibfarben/Writing colours



Click! Das erste modulare System, das zwei Stifte clever verlinkt. Mit Viscoglide®-Technologie für außergewöhnlich weiches und gleitendes Schreiben. Strichstärke Extrabreit (XB).

Click! The first modular system that cleverly links two pens. With Viscoglide®-technology for extraordinarily smooth and gliding writing. Line width extra wide (XB).

\*Gehäuse aus > 85% biobasiertem Kunststoff. Klimaneutral hergestellt.

\*Pen body made of > 85% biobased plastic. Produced climate neutrally.

# Inspiration



## Farben Colours

### Link-It Slider

4er-Stiftebox /  
Pencil case of 4

Verfügbar ab /  
Available from: ≥ 100 St. / pcs.  
Bestell-Nr. / Ref. No.: 954594

Kappe /  
Cap



O10

O25

O43

O34

Schaft /  
Barrel



G12/

G12/

G12/

G12/

O70

O70

O70

O70

Adapter /  
Adapter



O10

O25

O43

O34

Mine / Refill:



### Verschiedene Link-It Schreibsysteme / Combine different Link-It writing systems:

2er-Set /  
Set of 2

≥ 300 St. / pcs.  
954530

2 Stifte aus den  
links vordefinierten  
Kombinationen /  
2 pens of the  
predefined com-  
binations on the  
left-hand side

8er-Stiftebox /  
Pencil case of 8

≥ 100 St. / pcs.  
942098

8 ... Stifte aus den  
vordefinierten Kombinationen  
des Link-It Sliders, Link-It  
Fineliners und Link-It  
Highlighters /  
... pens of the predefined combinations  
of Link-  
It Slider, Link-It Fineliner and Link-It  
Highlighter

4er-Stiftebox /  
Pencil case of 4

≥ 100 St. / pcs.  
942094

4 ... Stifte aus den vordefinierten  
Kombinationen des Link-It Sliders,  
Link-It Fineliners und Link-It  
Highlighters /  
... pens of the predefined combinations  
of Link-  
It Slider, Link-It Fineliner and Link-It  
Highlighter

2er-Set /  
Set of 2

≥ 300 St. /  
pcs.  
942092

2 ... Stifte aus den vordefinierten  
Kombinationen des Link-It Sliders,  
Link-It Fineliners und Link-It  
Highlighters /  
... pens of the predefined combinations  
of Link-  
It Slider, Link-It Fineliner and Link-It  
Highlighter

## Druckflächen (in mm) Imprint positions (in mm)

Siebdruck / Screen printing

Tampondruck / Pad printing

Digitaldruck / Digital printing

D1.1: 22 × 5,5, D1.2: 27,5 × 5,5, D16: 60 × 10 / 106 × 10,  
D17: 43 × 9 / 87 × 9

Filmtransfer / Film transfer printing

Gravur / Engraving



# Take 4 Promo



Mine/Refill Take 4 Refill

Vierfarb-Kugelschreiber mit den Schreibfarben schwarz, rot, blau und grün. Schneller und komfortabler Farbwechsel durch farbige Schieber. Umwelt- und ressourcenschonend mit einem Gehäuse aus Recycling-Kunststoff. Stabiler Metallclip. Mit Viscoglide®-Technologie für außergewöhnlich weiches und gleitendes Schreiben. Strichstärke Medium (M).  
Nachfüllbar mit Schneider-Mine „Take 4 Refill“.

Four-colour ballpoint pen with the writing colours black, red, blue and green. Quick and comfortable colour change by coloured push buttons. Eco-friendly and resource-saving pen body made of recycled plastic. Sturdy metal clip. With Viscoglide® technology for extraordinarily smooth and gliding writing. Line width M.  
Replaceable with Schneider 'Take 4 Refill'.

\*Gehäuse aus 92 % Recycling-Kunststoff. Klimaneutral hergestellt.

\*Pen body made of 92% recycled plastic. Produced climate neutrally.



EuCertPlast



# Inspiration



## Farben Colours

### Verfügbar ab / Available from:

Bestell-Nr. / Ref. No.:	≥100 St. / pcs.						≥100 St. / pcs.						≥100 St. / pcs.					
	938 049	938 085	938 082	938 083	938 084	938 081	938 000	938 005	938 002	938 003	938 004	938 001	938 020	938 025	938 022	938 023	938 024	938 021

Oberteil + Schieber /  
Upper part + push  
buttons



Zwischenstück /  
Intermediate piece

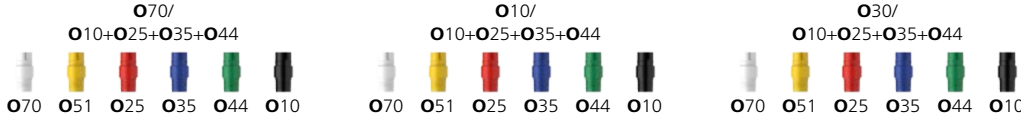

Vorderteil /  
Front part

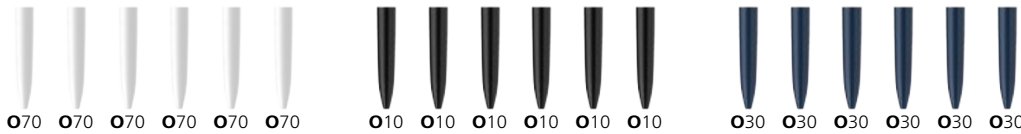

Sondergehäusefarbe auf Anfrage / Special colours for pen body upon request  
Mindestmenge / Minimum quantity: ≥10.000 St. / pcs.  
Bestell-Nr. / Ref. No.: 938099

## Druckflächen (in mm) Imprint positions (in mm)

### Siebdruck / Screen printing

S2.1: 25 × 19, S2.2: 19 × 34 (≤ 5.000), S3: 35 × 31, S25: 5 × 34

### Tampondruck / Pad printing

T19/T20: 26 × 7

### Digitaldruck / Digital printing

D22/D23/D24: 35 × 7, D26/D27/D28: 5 × 7, D19/D20/D21: 26 × 7

### Filmtransfer / Film transfer printing

### Gravur / Engraving

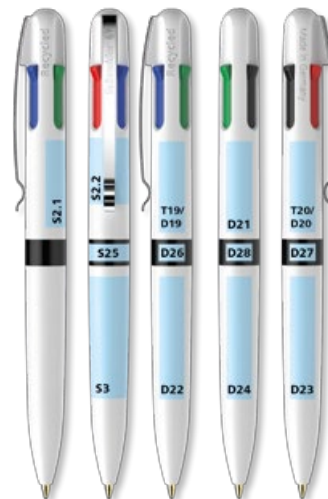

# Epsilon



## Mine/Refill Slider 755 XB

Eine Bestückung mit anderer Mine ist auf Anfrage möglich.  
Can be equipped with other refills upon request.

Kugelschreiber in klassischem Design. Moderne Stilelemente wie der elegante, teilweise versenkte Metallclip runden den Kugelschreiber optisch perfekt ab. Ausgestattet mit Schneider-Metall-Großraummine Slider 755 XB mit Viscoglide®-Technologie für außergewöhnlich weiches und gleitendes Schreiben.

Ballpoint pen with classic design featuring modern elements like the elegant, partially recessed metal clip. Equipped with Schneider giant metal refill Slider 755 XB with Viscoglide®-Technologie for extraordinarily easy and gliding writing.

Klimaneutral hergestellt.  
Produced climate neutrally.

# Inspiration



## Farben Colours

**Verfügbar ab / Available from:**    ≥ 100 St. / pcs.    ≥ 100 St. / pcs.    ≥ 100 St. / pcs.    ≥ 100 St. / pcs.    ≥ 100 St. / pcs.    ≥ 100 St. / pcs.    ≥ 100 St. / pcs.  
**Bestell-Nr. / Ref. No.:**    938601    938685    938681    938683    938682    938684    938699

Stopfen / Plug

○10

○70

○10

○10

○70

○70

Schaft / Barrel



Vordefinierte Kombinationen wie links / Predefined combinations as on the left-hand side

○10/  
G38

○70/  
G12

○10/  
G10

○10/  
G10

○70/  
G10

○70/  
G10

Mine / Refill:



Sondergehäusefarbe auf Anfrage / Special colours for pen body upon request  
 Mindestmenge / Minimum quantity: ≥ 10.000 St. / pcs.  
 Bestell-Nr. / Ref. No.: 938699

## Druckflächen (in mm) Imprint positions (in mm)

Siebdruck / Screen printing

Tampondruck / Pad printing

T1.1: 45 × 4,5 , T1.2: 45 × 4,5 , T7: 45 × 3

Digitaldruck / Digital printing

Filmtransfer / Film transfer printing

Gravur / Engraving



# Epsilon Touch



## Mine/Refill Slider 755 XB

Eine Bestückung mit anderer Mine ist auf Anfrage möglich.  
Can be equipped with other refills upon request.

Touchpen für die Bedienung von Tablets und Smartphones aus opakem Kunststoff mit glänzender Oberfläche. Moderne Stilelemente wie der elegante, teilweise versenkte Metallclip runden den Kugelschreiber optisch perfekt ab. Ausgestattet mit Schneider-Metall-Großraummine Slider 755 XB mit Viscoglide®-Technologie für außergewöhnlich weiches und gleitendes Schreiben.

Stylus-ballpoint pen to operate on tablets and smartphones in opaque plastics with shiny surface. Modern elements like the elegant, partially recessed metal clip. Equipped with Schneider giant metal refill Slider 755 XB with Viscoglide®-Technologie for extraordinarily easy and gliding writing.

Klimaneutral hergestellt.

Produced climate neutrally.

# Inspiration



## Farben Colours

<b>Verfügbar ab / Available from:</b>	≥ 100 St. / pcs.	≥ 100 St. / pcs.	≥ 100 St. / pcs.	≥ 100 St. / pcs.	≥ 100 St. / pcs.	≥ 100 St. / pcs.	≥ 100 St. / pcs.
<b>Bestell-Nr. / Ref. No.:</b>	938701	938703	938781	938783	938782	938784	938799

Touchkämpchen /  
Touch plug

Schaft /  
Barrel

G10



O70/  
G12

G10



O10/  
G56

G10



O10/  
G10

G10



O10/  
G10

G10



O70/  
G10

G10



O70/  
G10

Vordefinierte  
Kombinationen  
wie links /  
Predefined com-  
binations as on  
the left-hand side

Mine / Refill:



Sondergehäusefarbe auf Anfrage / Special colours for pen body upon request  
Mindestmenge / Minimum quantity: ≥ 10.000 St. / pcs.  
Bestell-Nr. / Ref. No.: 938799

## Druckflächen (in mm) Imprint positions (in mm)

Siebdruck / Screen printing

Tampondruck / Pad printing

T1.1: 45 × 4,5, T1.2: 45 × 4,5, T7: 45 × 3

Digitaldruck / Digital printing

Filmtransfer / Film transfer printing

Gravur / Engraving



# Like (opak / opaque)



#### Mine/Refill 774 M

Eine Bestückung mit anderer Mine ist auf Anfrage möglich.  
Can be equipped with other refills upon request.

Druckkugelschreiber aus opakem Kunststoff in 10 frischen Farben. Fein mattierte Oberfläche mit rutschfest gummierter Griffzone. Ausgestattet mit Schneider-Mine 774 M.

Retractable ballpoint pen in opaque plastics, available in 10 fresh colours. Fine, frosted matt surface with rubberised anti-slip grip zone. Equipped with Schneider refill 774 M.

Klimaneutral hergestellt.

Produced climate neutrally.

## Mix & Match

Mit dem ausgeklügelten Prinzip Mix & Match können mehrere Farben miteinander kombiniert werden.  
With the ingenious "Mix & Match" principle, several colours can be combined with each other.



## Farben Colours

**Verfügbar ab / Available from:** ≥300 St. / pcs.  
**Bestell-Nr. / Ref. No.:** 936599

**Farbauswahl / Select colour:**

Druckknopf / Push button	O70	O51	O64	O25	O93	O97	O35	O37	O48	-	-	O10
Cliphülse / Clip sleeve	O70	O51	O64	O25	O93	O97	O35	O37	O48	-	-	O10
Oberteil / Upper part	O70	O51	O64	O25	O93	O97	O35	O37	O48	-	-	O10
Vorderteil / Front part	O70	O51	O64	O25	O93	O97	O35	O37	O48	G42	G69	O10
	<b>G70</b>	<b>G51</b>	<b>G64</b>	<b>G25</b>	<b>G93</b>	<b>G98</b>	<b>G35</b>	<b>G37</b>	<b>G48</b>			<b>G10</b>

Sondergehäusefarbe auf Anfrage / Special colours for pen body upon request  
Mindestmenge / Minimum quantity: ≥10.000 St. / pcs.  
Bestell-Nr. / Ref. No.: 936599

## Druckflächen (in mm) Imprint positions (in mm)

### Siebdruck / Screen printing

S2: 54 × 37, S8: 23 × 37

### Tampondruck / Pad printing

T4: 42 × 5,5

### Digitaldruck / Digital printing

D4: 48 × 6, D19: 73 × 7,5, D20: 73 × 7,5, D21: 73 × 7,5

### Filmtransfer / Film transfer printing

### Gravur / Engraving

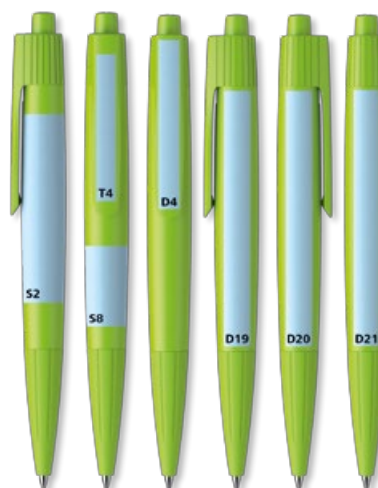

# Like (transparent)



## Mine/Refill 774 M

Eine Bestückung mit anderer Mine ist auf Anfrage möglich.  
Can be equipped with other refills upon request.

Druckkugelschreiber aus transparentem Kunststoff in 12 frischen Farben. Fein mattierte Oberfläche mit rutschfest gummierter Griffzone. Ausgestattet mit Schneider-Mine 774 M.

Retractable ballpoint pen in transparent plastics, available in 12 fresh colours. Fine, frosted matt surface with rubberised antislip grip zone. Equipped with Schneider refill 774 M.

*Klimaneutral hergestellt.  
Produced climate neutrally.*



## Mix & Match

Mit dem ausgeklügelten Prinzip Mix & Match können mehrere Farben miteinander kombiniert werden.  
With the ingenious "Mix & Match" principle, several colours can be combined with each other.



## Farben Colours

**Verfügbar ab / Available from:** ≥300 St. / pcs.  
**Bestell-Nr. / Ref. No.:** 936599

**Farbauswahl / Select colour:**

Druckknopf / Push button	T71	T51	T64	T25	T93	T97	T34	T39	T48	T42	T69	T10
Cliphülse / Clip sleeve	T71	T51	T64	T25	T93	T97	T34	T39	T48	T42	T69	T10
Oberteil / Upper part	T71	T51	T64	T25	T93	T97	T34	T39	T48	T42	T69	T10
Vorderteil / Front part	T71	T51	T64	T25	T93	T97	T34	T39	T48	T42	T69	T10
	G70	G51	G64	G25	G93	G98	G35	G39	G48	G42	G69	G10

Sondergehäusefarbe auf Anfrage / Special colours for pen body upon request  
Mindestmenge / Minimum quantity: ≥10.000 St. / pcs.  
Bestell-Nr. / Ref. No.: 936599

## Druckflächen (in mm) Imprint positions (in mm)

### Siebdruck / Screen printing

S2: 54 × 37, S8: 23 × 37

### Tampondruck / Pad printing

T4: 42 × 5,5

### Digitaldruck / Digital printing

D4: 48 × 6, D19: 73 × 7,5, D20: 73 × 7,5, D21: 73 × 7,5

### Filmtransfer / Film transfer printing

### Gravur / Engraving

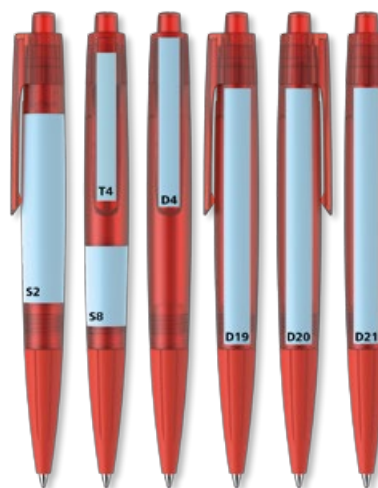

# Dynamix



#### Mine/Refill 774 M

Eine Bestückung mit anderer Mine ist auf Anfrage möglich.  
Can be equipped with other refills upon request.

Druckkugelschreiber aus transparentem oder opakem Kunststoff mit fein mattierter Oberfläche.  
Ausgestattet mit Schneider-Mine 774 M.

Retractable ballpoint pen available in transparent or opaque plastics with matt surface.  
Equipped with Schneider refill 774 M.

Klimaneutral hergestellt.  
Produced climate neutrally.

## Mix & Match

Mit dem ausgeklügelten Prinzip Mix & Match können mehrere Farben miteinander kombiniert werden.  
With the ingenious "Mix & Match" principle, several colours can be combined with each other.



## Farben Colours

**Verfügbar ab / Available from:** ≥600 St. / pcs.  
**Bestell-Nr. / Ref. No.:** 930699

**Farbauswahl / Select colour:**

	O70	O10	T71	T52	T21	T34	T44	T10
Druckknopf / Push button	O70	O10	T71	T52	T21	T34	T44	T10
Cliphülse / Clip sleeve	O70	O10	T71	T52	T21	T34	T44	T10
Oberteil / Upper part	O70	O10	T71	T52	T21	T34	T44	T10
Spitze / Tip	O70	O10	T71	T52	T21	T34	T44	T10

Sondergehäusefarbe auf Anfrage / Special colours for pen body upon request  
Mindestmenge / Minimum quantity: ≥10.000 St. / pcs.  
Bestell-Nr. / Ref. No.: 930699

## Druckflächen (in mm) Imprint positions (in mm)

### Siebdruck / Screen printing

S2: 70 × 30, S8: 45 × 30

### Tampondruck / Pad printing

T4: 36 × 8

### Digitaldruck / Digital printing

D4: 27 × 8,5, D19: 90 × 7,5, D20: 90 × 7,5, D21: 90 × 7,5

### Filmtransfer / Film transfer printing

F2: 92, 360° (≥ 10.000)

### Gravur / Engraving

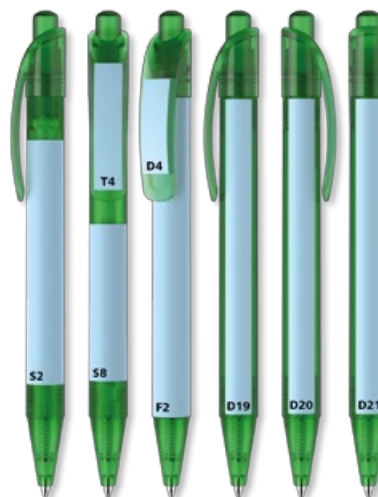

# Dynamix Recycling (opak / opaque)



#### Mine/Refill 774 M

Eine Bestückung mit anderer Mine ist auf Anfrage möglich.  
Can be equipped with other refills upon request.

Druckkugelschreiber aus opakem Kunststoff mit fein mattierter Oberfläche. Ausgestattet mit Schneider-Mine 774 M.  
Retractable ballpoint pen available in opaque plastics with matt surface. Equipped with Schneider refill 774 M.

*\*Gehäuse zu > 90 % (opak) aus Recycling-Kunststoff.  
Klimaneutral hergestellt.*

*\*Pen body made of >90 % (opaque) recycled plastic.  
Produced climate neutrally.*



EuCertPlast

## Mix & Match

Mit dem ausgeklügelten Prinzip Mix & Match können mehrere Farben miteinander kombiniert werden.  
With the ingenious "Mix & Match" principle, several colours can be combined with each other.



## Farben Colours

Verfügbar ab /  
Available from:  $\geq 600$  St. / pcs.  
Bestell-Nr. / Ref. No.: 930399

Farbauswahl / Select colour:

	O70	O64	O25	O96	O34	O48	O10
Druckknopf / Push button							
Cliphülse / Clip sleeve							
Oberteil / Upper part							
Spitze / Tip							

Sondergehäusefarbe auf Anfrage / Special colours for pen body upon request  
Mindestmenge / Minimum quantity:  $\geq 10.000$  St. / pcs.  
Bestell-Nr. / Ref. No.: 930399

## Druckflächen (in mm) Imprint positions (in mm)

### Siebdruck / Screen printing

S2: 70 x 30, S8: 45 x 30

### Tampondruck / Pad printing

T4: 36 x 8

### Digitaldruck / Digital printing

D4: 27 x 8,5, D19: 90 x 7,5, D20: 90 x 7,5, D21: 90 x 7,5

### Filmtransfer / Film transfer printing

F2: 92, 360° ( $\geq 10.000$ )

### Gravur / Engraving



# Dynamix Recycling (transparent)



#### Mine/Refill 774 M

Eine Bestückung mit anderer Mine ist auf Anfrage möglich.  
Can be equipped with other refills upon request.

Druckkugelschreiber aus transparentem Kunststoff mit fein mattierter Oberfläche. Ausgestattet mit Schneider-Mine 774 M.  
Retractable ballpoint pen available in transparent plastics with matt surface. Equipped with Schneider refill 774 M.

*\*Gehäuse zu 73 % (transparent) aus Recycling-Kunststoff.  
Klimaneutral hergestellt.*

*\*Pen body made of 73% (transparent) recycled plastic.  
Produced climate neutrally.*



EuCertPlast

## Mix & Match

Mit dem ausgeklügelten Prinzip Mix & Match können mehrere Farben miteinander kombiniert werden.  
With the ingenious "Mix & Match" principle, several colours can be combined with each other.



## Farben Colours

**Verfügbar ab / Available from:** ≥ 600 St. / pcs.  
**Bestell-Nr. / Ref. No.:** 930399

**Farbauswahl / Select colour:**

	T64	T25	T96	T34	T48
Druckknopf / Push button					
Cliphülse / Clip sleeve					
Oberteil / Upper part					
Spitze / Tip					

Sondergehäusefarbe auf Anfrage / Special colours for pen body upon request  
Mindestmenge / Minimum quantity: ≥ 10.000 St. / pcs.  
Bestell-Nr. / Ref. No.: 930399

## Druckflächen (in mm) Imprint positions (in mm)

### Siebdruck / Screen printing

S2: 70 × 30, S8: 45 × 30

### Tampondruck / Pad printing

T4: 36 × 8

### Digitaldruck / Digital printing

D4: 27 × 8,5, D19: 90 × 7,5, D20: 90 × 7,5, D21: 90 × 7,5

### Filmtransfer / Film transfer printing

F2: 92, 360° (≥ 10.000)

### Gravur / Engraving



# Dynamix Pro+



#### Mine/Refill 774 M

Eine Bestückung mit anderer Mine ist auf Anfrage möglich.  
Can be equipped with other refills upon request.

Druckkugelschreiber aus transparentem oder opakem Kunststoff mit fein mattierter Oberfläche. Hochwertig lackierte Cliphülse und Spitze. Ausgestattet mit Schneider-Mine 774 M.

Retractable ballpoint pen available in transparent or opaque plastics with matt surface. High-quality lacquered clip and tip. Equipped with Schneider refill 774 M.

Klimaneutral hergestellt.  
Produced climate neutrally.



## Mix & Match

Mit dem ausgeklügelten Prinzip Mix & Match können mehrere Farben miteinander kombiniert werden.  
With the ingenious "Mix & Match" principle, several colours can be combined with each other.



## Farben Colours

**Verfügbar ab / Available from:** ≥ 600 St. / pcs.  
**Bestell-Nr. / Ref. No.:** 937599

**Farbauswahl / Select colour:**

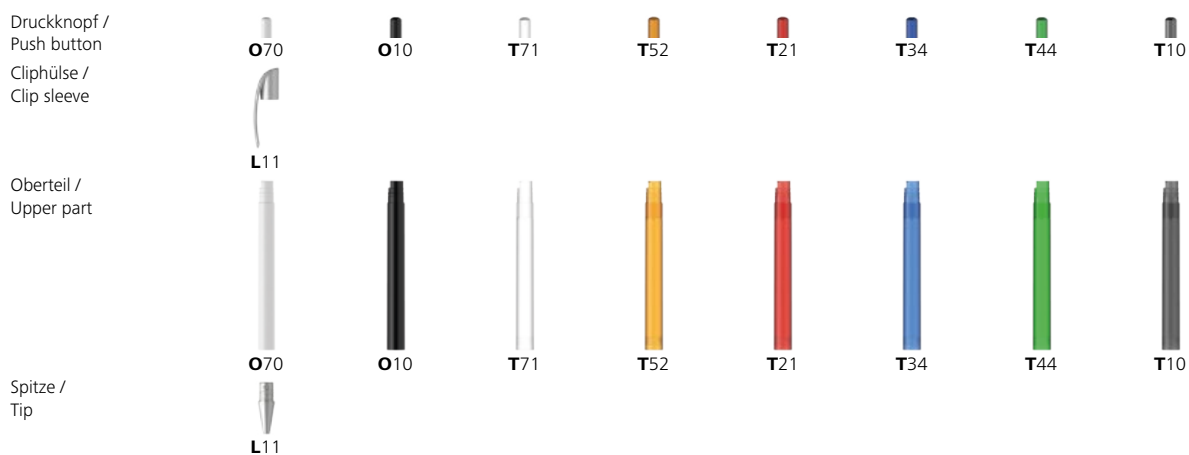

Sondergehäusefarbe auf Anfrage / Special colours for pen body upon request  
Mindestmenge / Minimum quantity: ≥ 10.000 St. / pcs.  
Bestell-Nr. / Ref. No.: 937599

## Druckflächen (in mm) Imprint positions (in mm)

### Siebdruck / Screen printing

S2: 70 × 30, S8: 45 × 30

### Tampondruck / Pad printing

T4: 36 × 8

### Digitaldruck / Digital printing

D19: 90 × 7,5, D20: 90 × 7,5, D21: 90 × 7,5

### Filmtransfer / Film transfer printing

F2: 92, 360° (≥ 10.000)

### Gravur / Engraving

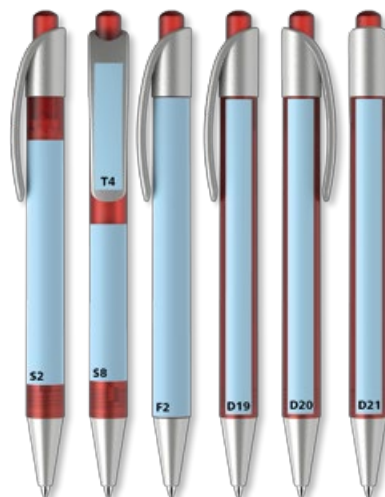

# Dynamix Pro+ Soft Touch



## Mine/Refill 774 M

Eine Bestückung mit anderer Mine ist auf Anfrage möglich.  
Can be equipped with other refills upon request.

Druckkugelschreiber aus transparentem oder opakem Kunststoff. Oberteil mit mattierter Soft Touch-Lackierung. Hochwertig lackierte Cliphülse und Spitze. Ausgestattet mit Schneider-Mine 774 M.

Retractable ballpoint pen available in transparent or opaque plastics. Upper part with matt lacquered soft touch surface. High-quality lacquered clip and tip. Equipped with Schneider refill 774 M.

Klimaneutral hergestellt.  
Produced climate neutrally.

## Mix & Match





















Mit dem ausgeklügelten Prinzip Mix & Match können mehrere Farben miteinander kombiniert werden.  
With the ingenious "Mix & Match" principle, several colours can be combined with each other.



## Farben Colours

**Verfügbar ab / Available from:** ≥ 600 St. / pcs.  
**Bestell-Nr. / Ref. No.:** 937699

**Farbauswahl / Select colour:**

Druckknopf / Push button								
Cliphülse / Clip sleeve								
Oberteil / Upper part								
Spitze / Tip								
	<b>O70</b>	<b>O10</b>	<b>T71</b>	<b>T52</b>	<b>T21</b>	<b>T34</b>	<b>T44</b>	<b>T10</b>
	<b>L11</b>							
	<b>LO70</b>	<b>LO10</b>		<b>LT64</b>	<b>LT25</b>	<b>LT34</b>	<b>LT44</b>	
	<b>L11</b>							

Sondergehäusefarbe auf Anfrage / Special colours for pen body upon request  
Mindestmenge / Minimum quantity: ≥ 10.000 St. / pcs.  
Bestell-Nr. / Ref. No.: 937699

## Druckflächen (in mm) Imprint positions (in mm)

### Siebdruck / Screen printing

S2: 70 × 30, S8: 45 × 30

### Tampondruck / Pad printing

T4: 36 × 8

### Digitaldruck / Digital printing

D19: 90 × 7,5, D20: 90 × 7,5, D21: 90 × 7,5

### Filmtransfer / Film transfer printing

### Gravur / Engraving

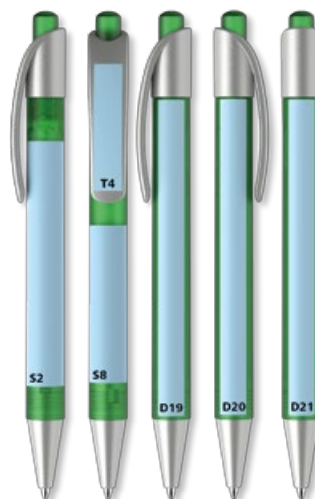

# Essential



## Mine/Refill 774 M

Eine Bestückung mit anderer Mine ist auf Anfrage möglich.  
Can be equipped with other refills upon request.

Druckkugelschreiber aus transparentem oder opakem Kunststoff mit glänzender Oberfläche.  
Ausgestattet mit Schneider-Mine 774 M.

Retractable ballpoint pen available in transparent or opaque plastics with shiny surface.  
Equipped with Schneider refill 774 M.

Klimaneutral hergestellt.  
Produced climate neutrally.

## Mix & Match

Mit dem ausgeklügelten Prinzip Mix & Match können mehrere Farben miteinander kombiniert werden.  
With the ingenious "Mix & Match" principle, several colours can be combined with each other.



## Farben Colours

**Verfügbar ab / Available from:**  $\geq 1.000$  St. / pcs.  
**Bestell-Nr. / Ref. No.:** 937399

**Farbauswahl / Select colour:**

Cliphülse / Clip sleeve	O70	O53	O21	O35	O47	O10	T71	T50	T62	T21	T93	T34	T44	T10
Oberteil / Upper part	[Image]	[Image]	[Image]	[Image]	[Image]	[Image]	[Image]	[Image]	[Image]	[Image]	[Image]	[Image]	[Image]	[Image]
Spitze / Tip	O70	O53	O21	O35	O47	O10	T71	T50	T62	T21	T93	T34	T44	T10

Sondergehäusefarbe auf Anfrage / Special colours for pen body upon request  
Mindestmenge / Minimum quantity:  $\geq 10.000$  St. / pcs.  
Bestell-Nr. / Ref. No.: 937399

## Druckflächen (in mm) Imprint positions (in mm)

### Siebdruck / Screen printing

S2: 80 × 28, S8: 45 × 28

### Tampondruck / Pad printing

T4: 35 × 5,5

### Digitaldruck / Digital printing

D4: 40 × 6, D19: 117 × 7, D20: 117 × 7, D21: 117 × 7

### Filmtransfer / Film transfer printing

—

### Gravur / Engraving

—

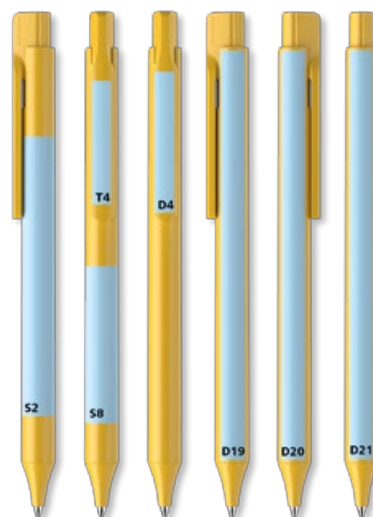

# Essential Soft Touch



## Mine/Refill 774 M

Eine Bestückung mit anderer Mine ist auf Anfrage möglich.  
Can be equipped with other refills upon request.

Druckkugelschreiber aus opakem Kunststoff. Oberteil mit mattierter Soft Touch-Lackierung, Cliphülse und Spitze mit glänzender Oberfläche. Ausgestattet mit Schneider-Mine 774 M.

Retractable ballpoint pen available in opaque plastics. Upper part with matt lacquered soft touch surface, clip sleeve and barrel tip with shiny surface. Equipped with Schneider refill 774 M.

Klimaneutral hergestellt.

Produced climate neutrally.

## Mix & Match

Mit dem ausgeklügelten Prinzip Mix & Match können mehrere Farben miteinander kombiniert werden.  
With the ingenious "Mix & Match" principle, several colours can be combined with each other.



## Farben Colours

**Verfügbar ab / Available from:**  $\geq 1.000$  St. / pcs.  
**Bestell-Nr. / Ref. No.:** 937499

**Farbauswahl / Select colour:**

Cliphülse / Clip sleeve	O70	O53	O21	O35	O47	O10	T71	T50	T62	T21	T93	T34	T44	T10
Oberteil / Upper part	O70	O53	O21	O35	O47	O10								
Spitze / Tip	LO70	LO53	LO21	LO35	LO47	LO10	T71	T50	T62	T21	T93	T34	T44	T10

Sondergehäusefarbe auf Anfrage / Special colours for pen body upon request  
Mindestmenge / Minimum quantity:  $\geq 10.000$  St. / pcs.  
Bestell-Nr. / Ref. No.: 937499

## Druckflächen (in mm) Imprint positions (in mm)

### Siebdruck / Screen printing

S2: 80 × 28, S8: 45 × 28

### Tampondruck / Pad printing

T4: 35 × 5,5

### Digitaldruck / Digital printing

D4: 40 × 6, D19: 117 × 7, D20: 117 × 7, D21: 117 × 7

### Filmtransfer / Film transfer printing

—

### Gravur / Engraving

—

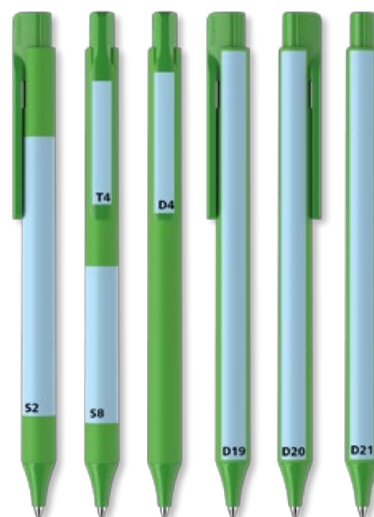

Update

# Evo



## Mine/Refill 774 M

Eine Bestückung mit anderer Mine ist auf Anfrage möglich.  
Can be equipped with other refills upon request.

Druckkugelschreiber aus transparentem oder opakem Kunststoff mit glänzender Oberfläche. Clip und Druckknopf aus Metall.  
Ausgestattet mit Schneider-Mine 774 M.

Retractable ballpoint pen available in transparent or opaque plastics with shiny surface. Metal clip and push button.  
Equipped with Schneider refill 774 M.

Klimaneutral hergestellt.  
Produced climate neutrally.



## Mix & Match

Mit dem ausgeklügelten Prinzip Mix & Match können mehrere Farben miteinander kombiniert werden.  
With the ingenious "Mix & Match" principle, several colours can be combined with each other.



## Farben Colours

**Verfügbar ab / Available from:**  $\geq 300$  St. / pcs.  
**Bestell-Nr. / Ref. No.:** 939699

**Farbauswahl / Select colour:**

Oberteil /  
Upper part

Spitze /  
Tip

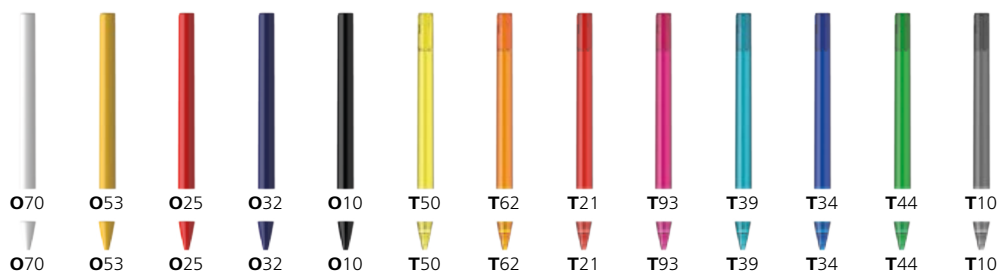

Sondergehäusefarbe auf Anfrage / Special colours for pen body upon request  
Mindestmenge / Minimum quantity:  $\geq 10.000$  St. / pcs.  
Bestell-Nr. / Ref. No.: 939699

## Druckflächen (in mm) Imprint positions (in mm)

### Siebdruck / Screen printing

S2:  $80 \times 28$  ( $\geq 1.000$ ), S8:  $45 \times 28$

### Tampondruck / Pad printing

T4:  $37 \times 6$

### Digitaldruck / Digital printing

D19:  $107 \times 7$ , D20:  $107 \times 7$ , D21:  $107 \times 7$

### Filmtransfer / Film transfer printing

F2:  $109, 360^\circ$  ( $\geq 10.000$ )

### Gravur / Engraving

G4:  $37 \times 6$

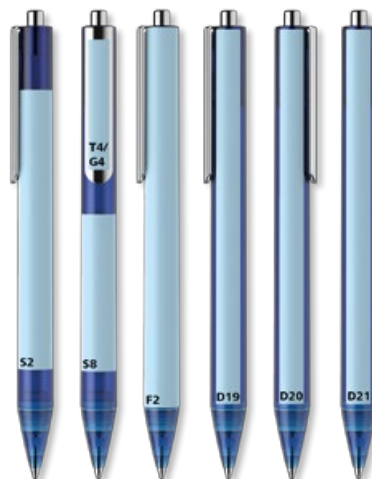

# Evo Recycling



## Mine/Refill 774 M

Eine Bestückung mit anderer Mine ist auf Anfrage möglich.  
Can be equipped with other refills upon request.

Druckkugelschreiber aus opakem Kunststoff mit glänzender Oberfläche. Clip und Druckknopf aus Metall. Ausgestattet mit Schneider-Mine 774 M.

Retractable ballpoint pen available in opaque plastics with shiny surface. Metal clip and push button. Equipped with Schneider refill 774 M.

*\*Gehäuse zu > 90% aus Recycling-Kunststoff. Klimaneutral hergestellt.*

*\*Pen body made of > 90% recycled plastic. Produced climate neutrally.*

# Inspiration



## Farben Colours

Verfügbar ab /  
Available from:  $\geq 300$  St. / pcs.  
Bestell-Nr. / Ref. No.: 938899

Farbauswahl / Select colour:

Oberteil /  
Upper part



O70



O10

Spitze /  
Tip

O70

O10

## Druckflächen (in mm) Imprint positions (in mm)

### Siebdruck / Screen printing

S2:  $80 \times 28$  ( $\geq 1.000$ ), S8:  $45 \times 28$

### Tampondruck / Pad printing

T4:  $37 \times 6$

### Digitaldruck / Digital printing

D19:  $95 \times 7$ , D20:  $95 \times 7$ , D21:  $95 \times 7$

### Filmtransfer / Film transfer printing

F2:  $109, 360^\circ$  ( $\geq 10.000$ )

### Gravur / Engraving

G4:  $37 \times 6$

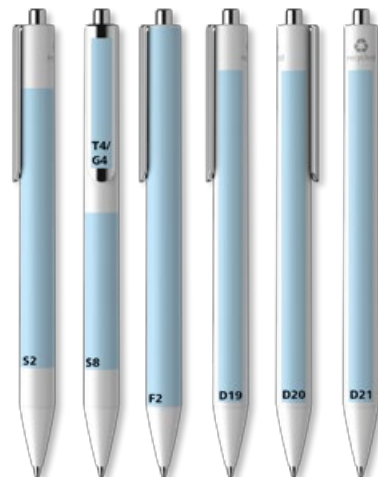



# Evo Pro



## Mine/Refill 774 M

Eine Bestückung mit anderer Mine ist auf Anfrage möglich.  
Can be equipped with other refills upon request.

Druckkugelschreiber aus transparentem oder opakem Kunststoff mit glänzender Oberfläche. Gehäusespitze, Clip und Druckknopf aus Metall. Ausgestattet mit Schneider-Mine 774 M.

Retractable ballpoint pen available in transparent or opaque plastics with shiny surface. Barrel tip, clip and push button in metal. Equipped with Schneider refill 774 M.

Klimaneutral hergestellt.  
Produced climate neutrally.

# Inspiration



## Farben Colours

Verfügbar ab /  
Available from:  $\geq 300$  St. / pcs.  
Bestell-Nr. / Ref. No.: 939899

Farbauswahl / Select colour:

Oberteil /  
Upper part

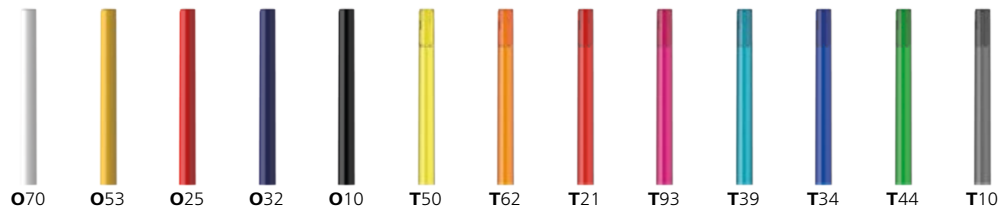

Sondergehäusefarbe auf Anfrage / Special colours for pen body upon request  
Mindestmenge / Minimum quantity:  $\geq 10.000$  St. / pcs.  
Bestell-Nr. / Ref. No.: 939899

## Druckflächen (in mm) Imprint positions (in mm)

### Siebdruck / Screen printing

S2:  $80 \times 28$  ( $\geq 1.000$ ), S8:  $45 \times 28$

### Tampondruck / Pad printing

T4:  $37 \times 6$

### Digitaldruck / Digital printing

D19:  $107 \times 7$ , D20:  $107 \times 7$ , D21:  $107 \times 7$

### Filmtransfer / Film transfer printing

F2:  $109, 360^\circ$  ( $\geq 10.000$ )

### Gravur / Engraving

G4:  $37 \times 6$



# Evo Pro Recycling



## Mine/Refill 774 M

Eine Bestückung mit anderer Mine ist auf Anfrage möglich.  
Can be equipped with other refills upon request.

Druckkugelschreiber aus opakem Kunststoff mit glänzender Oberfläche. Gehäusespitze, Clip und Druckknopf aus Metall.  
Ausgestattet mit Schneider-Mine 774 M.

Retractable ballpoint pen available in opaque plastics with shiny surface. Barrel tip, clip and push button in metal.  
Equipped with Schneider refill 774 M.

*\*Gehäuse zu > 90% aus Recycling-Kunststoff. Klimaneutral hergestellt.*

*\*Pen body made of > 90% recycled plastic. Produced climate neutrally.*

## Inspiration



## Farben Colours

### Verfügbar ab /

Available from:  $\geq 300$  St. / pcs.

Bestell-Nr. / Ref. No.: 938999

Farbauswahl / Select colour:

Oberteil /  
Upper part



O70



O10

## Druckflächen (in mm) Imprint positions (in mm)

### Siebdruck / Screen printing

S2:  $80 \times 28$  ( $\geq 1.000$ ), S8:  $45 \times 28$

### Tampondruck / Pad printing

T4:  $37 \times 6$

### Digitaldruck / Digital printing

D19:  $95 \times 7$ , D20:  $95 \times 7$ , D21:  $95 \times 7$

### Filmtransfer / Film transfer printing

F2:  $109, 360^\circ$  ( $\geq 10.000$ )

### Gravur / Engraving

G4:  $37 \times 6$

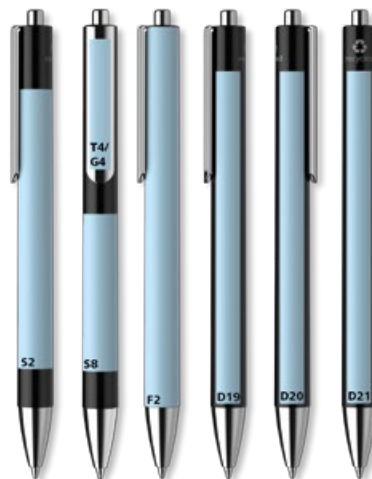

# Evo Pro Soft Touch



## Mine/Refill 774 M

Eine Bestückung mit anderer Mine ist auf Anfrage möglich.  
Can be equipped with other refills upon request.

Druckkugelschreiber aus transparentem oder opakem Kunststoff. Oberteil mit mattierter Soft Touch-Lackierung.  
Gehäusespitze, Clip und Druckknopf aus Metall. Ausgestattet mit Schneider-Mine 774 M.

Retractable ballpoint pen available in transparent or opaque plastics. Upper part with matt lacquered soft touch surface.  
Barrel tip, clip and push button in metal. Equipped with Schneider refill 774 M.

Klimaneutral hergestellt.

Produced climate neutrally.



# Inspiration



## Farben Colours

Verfügbar ab /  
Available from:  $\geq 300$  St. / pcs.  
Bestell-Nr. / Ref. No.: 939999

Oberteil /  
Upper part

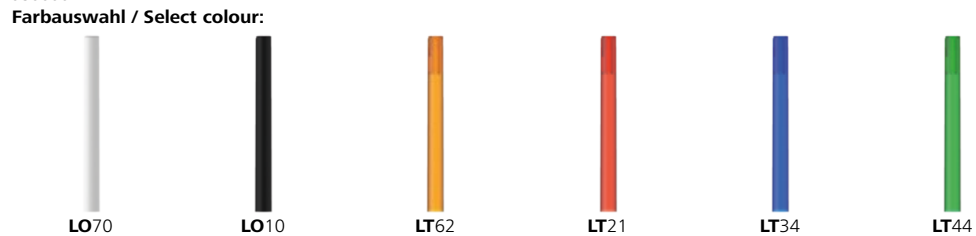

Sondergehäusefarbe auf Anfrage / Special colours for pen body upon request  
Mindestmenge / Minimum quantity:  $\geq 10.000$  St. / pcs.  
Bestell-Nr. / Ref. No.: 939999

## Druckflächen (in mm) Imprint positions (in mm)

### Siebdruck / Screen printing

S2:  $80 \times 28$  ( $\geq 1.000$ ), S8:  $45 \times 28$

### Tampondruck / Pad printing

T4:  $37 \times 6$

### Digitaldruck / Digital printing

D19:  $107 \times 7$ , D20:  $107 \times 7$ , D21:  $107 \times 7$

### Filmtransfer / Film transfer printing

### Gravur / Engraving

G4:  $37 \times 6$

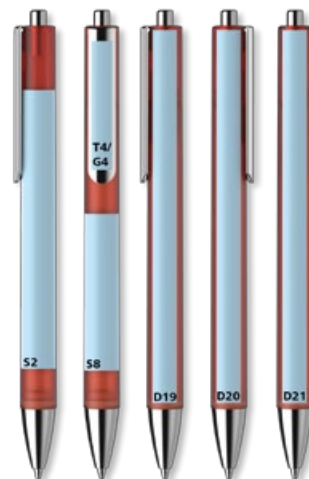

# Evo Pro+



**Mine/Refill 774 M**



oder/or **Mine/Refill 778 XB**



Eine Bestückung mit anderer Mine ist auf Anfrage möglich.  
Can be equipped with other refills upon request.

Druckkugelschreiber aus Kunststoff mit lackierter Oberfläche. Gehäusespitze, Clip und Druckknopf aus Metall. Wahlweise ausgestattet mit Schneider-Mine 774 M oder Schneider-Mine 778 XB.

Retractable ballpoint pen in plastics with lacquered surface. Barrel tip, clip and push button in metal. Equipped with either Schneider refill 774 M or Schneider refill 778 XB.

Klimaneutral hergestellt.

Produced climate neutrally.

# Inspiration



## Farben Colours

**Verfügbar ab /**  
**Available from:** ≥300 St. / pcs.  
**Bestell-Nr. / Ref. No.:** 939799

**Farbauswahl / Select colour:**

Oberteil /  
Upper part



L70



L56



L10

Sondergehäusefarbe auf Anfrage / Special colours for pen body upon request  
Mindestmenge / Minimum quantity: ≥10.000 St. / pcs.  
Bestell-Nr. / Ref. No.: 939799

## Druckflächen (in mm) Imprint positions (in mm)

### Siebdruck / Screen printing

S2: 80 × 28 (≥ 1.000), S8: 45 × 28

### Tampondruck / Pad printing

T4: 37 × 6

### Digitaldruck / Digital printing

—

### Filmtransfer / Film transfer printing

—

### Gravur / Engraving

G4: 37 × 6



Update

# Haptify



## Mine/Refill 774 M

Eine Bestückung mit anderer Mine ist auf Anfrage möglich.  
Can be equipped with other refills upon request.

Druckkugelschreiber aus transparentem oder opakem Kunststoff, glänzender Oberfläche und einer rutschfest gummierten Dreikant-Griffzone. Clip und Druckknopf aus Metall. Ausgestattet mit Schneider-Mine 774 M.

Retractable ballpoint pen available in transparent or opaque plastics, shiny surface and with a rubberised three-edged anti-slip grip zone. Metal clip and push button. Equipped with Schneider refill 774 M.

Klimaneutral hergestellt.

Produced climate neutrally.

## Mix & Match

Mit dem ausgeklügelten Prinzip Mix & Match können mehrere Farben miteinander kombiniert werden.  
With the ingenious "Mix & Match" principle, several colours can be combined with each other.



## Farben Colours

**Verfügbar ab / Available from:**  $\geq 300$  St. / pcs.  
**Bestell-Nr. / Ref. No.:** 939199

**Farbauswahl / Select colour:**

Oberteil /  
Upper part



O70



T62



T25



T34



T44



O10

Vorderteil /  
Front part



O70/  
G10



T62/  
G62



T25/  
G25



T34/  
G34



T44/  
G44



O10/  
G10

Sondergehäusefarbe auf Anfrage / Special colours for pen body upon request  
Mindestmenge / Minimum quantity:  $\geq 10.000$  St. / pcs.  
Bestell-Nr. / Ref. No.: 939199

## Druckflächen (in mm) Imprint positions (in mm)

### Siebdruck / Screen printing

S2: 38 x 12

### Tampondruck / Pad printing

T19: 38 x 7,5

### Digitaldruck / Digital printing

—

### Filmtransfer / Film transfer printing

—

### Gravur / Engraving

—





# Haptify Promo



**Mine/Refill 774 M**

Eine Bestückung mit anderer Mine ist auf Anfrage möglich.  
Can be equipped with other refills upon request.

Druckkugelschreiber aus transparentem oder opakem Kunststoff, glänzender Oberfläche und einer rutschfest gummierten Dreikant-Griffzone. Ausgestattet mit Schneider-Mine 774 M.

Retractable ballpoint pen available in transparent or opaque plastics, shiny surface and a rubberised three-edged anti-slip grip zone. Equipped with Schneider refill 774 M.

*Klimaneutral hergestellt.  
Produced climate neutrally.*

## Mix & Match

Mit dem ausgeklügelten Prinzip Mix & Match können mehrere Farben miteinander kombiniert werden.  
With the ingenious "Mix & Match" principle, several colours can be combined with each other.



## Farben Colours

Verfügbar ab /  
Available from:  $\geq 300$  St. / pcs.  
Bestell-Nr. / Ref. No.: 937099

Farbauswahl / Select colour:

Druckknopf /  
Push button  
Clip /  
Clip

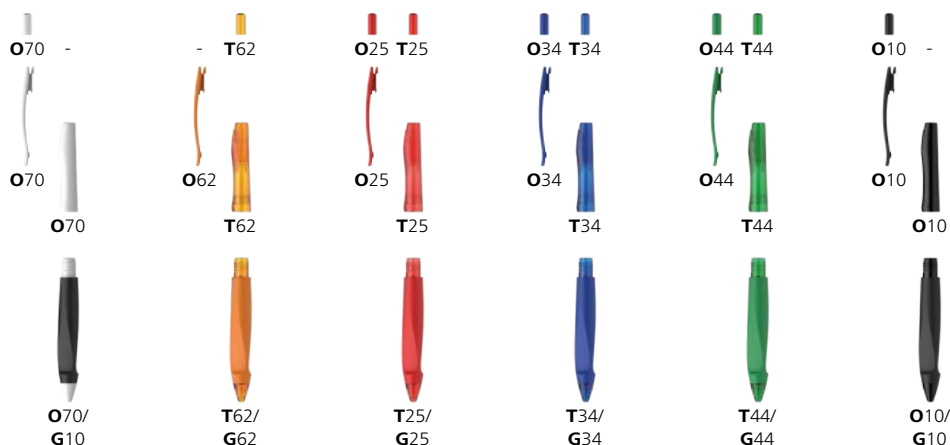

Sondergehäusefarbe auf Anfrage / Special colours for pen body upon request  
Mindestmenge / Minimum quantity:  $\geq 10.000$  St. / pcs.  
Bestell-Nr. / Ref. No.: 937099

## Druckflächen (in mm) Imprint positions (in mm)

### Siebdruck / Screen printing

S2: 38 x 12

### Tampondruck / Pad printing

T4: 45 x 5,5, T19: 38 x 7,5

### Digitaldruck / Digital printing

### Filmtransfer / Film transfer printing

### Gravur / Engraving



Update

# K 1



## Mine/Refill 774 M

Eine Bestückung mit anderer Mine ist auf Anfrage möglich.  
Can be equipped with other refills upon request.

Klassischer Druckkugelschreiber aus opakem Kunststoff mit glänzender Oberfläche. Clip und Druckknopf aus Metall.  
Ausgestattet mit Schneider-Mine 774 M.

Classical retractable ballpoint pen in opaque plastics with shiny surface. Metal clip and push button. Equipped with  
Schneider refill 774 M.

Klimaneutral hergestellt.  
Produced climate neutrally.



## Mix & Match

Mit dem ausgeklügelten Prinzip Mix & Match können mehrere Farben miteinander kombiniert werden.  
With the ingenious "Mix & Match" principle, several colours can be combined with each other.



## Farben Colours

**Verfügbar ab / Available from:** ≥ 600 St. / pcs.  
**Bestell-Nr. / Ref. No.:** 93148

≥ 1.000 St. / pcs.  
931499

**Farbauswahl / Select colour:**

Oberteilverlängerung /  
Upper part prolongation



Oberteil /  
Upper part



Vorderteil /  
Front part



Mine / Refill:



Sondergehäusefarbe auf Anfrage / Special colours for pen body upon request  
Mindestmenge / Minimum quantity: ≥ 10.000 St. / pcs.  
Bestell-Nr. / Ref. No.: 931499

## Druckflächen (in mm) Imprint positions (in mm)

### Siebdruck / Screen printing

S2: 55 × 15, S8: 12 × 29,5

### Tampondruck / Pad printing

T9: 7 × 7, T10: 8 × 9

### Digitaldruck / Digital printing

D19: 70 × 7 (9), D20: 70 × 7 (9), D21: 70 × 7

### Filmtransfer / Film transfer printing

### Gravur / Engraving



# K 1 Metal



## Mine/Refill 774 M

Eine Bestückung mit anderer Mine ist auf Anfrage möglich.  
Can be equipped with other refills upon request.

Druckkugelschreiber aus Kunststoff mit hochwertiger glänzender Silberlackierung. Clip, Zierring und Druckknopf aus Metall.  
Ausgestattet mit Schneider-Mine 774 M.

Retractable ballpoint pen in high-quality plastics with shiny silver lacquering. Clip, decorative ring and push button in metal.  
Equipped with Schneider refill 774 M.

*Klimaneutral hergestellt.  
Produced climate neutrally.*

# Inspiration



## Farben Colours

**Verfügbar ab /**  
**Available from:** ≥ 1.000 St. / pcs.  
**Bestell-Nr. / Ref. No.:** 936999

**Farbauswahl / Select colour:**

Oberteilverlängerung /  
Upper part prolongation

O70

O53

O64

O25

O31

O43

O10

T25

T34

T44

T10

Oberteil /  
Upper part



L11

Vorderteil /  
Front part

L11

Sondergehäusefarbe auf Anfrage / Special colours for pen body upon request  
Mindestmenge / Minimum quantity: ≥ 10.000 St. / pcs.  
Bestell-Nr. / Ref. No.: 936999

## Druckflächen (in mm) Imprint positions (in mm)

### Siebdruck / Screen printing

S2: 55 × 15, S8: 12 × 29,5

### Tampondruck / Pad printing

T9: 7 × 7, T10: 8 × 9

### Digitaldruck / Digital printing

—

### Filmtransfer / Film transfer printing

—

### Gravur / Engraving

—



# K 1 Biosafe



## Mine/Refill Express 739 M

Eine Bestückung mit anderer Mine ist auf Anfrage möglich.  
Can be equipped with other refills upon request.

Druckkugelschreiber mit einem Gehäuse aus biobasiertem Kunststoff. Clip und Druckknopf aus Metall.  
Ausgestattet mit Schneider-Großraummine Express 739 M.

Retractable ballpoint pen with pen body made of biobased plastic. Metal clip and push button.  
Equipped with Schneider refill Express 739 M.

*\*Gehäuse aus > 62 % biobasiertem Kunststoff. Klimaneutral hergestellt.*

*\*Pen body made of > 62% biobased plastic. Produced climate neutrally.*



# Inspiration



## Farben Colours

### Verfügbar ab /

Available from:  $\geq 1.000$  St. / pcs.

Bestell-Nr. / Ref. No.: 932899

### Farbauswahl / Select colour:

Oberteilverlängerung /  
Upper part prolongation

T25

T34

T42

T10

Oberteil /  
Upper part

O70

Vorderteil /  
Front part

O70

O70

Sondergehäusefarbe auf Anfrage / Special colours for pen body upon request  
Mindestmenge / Minimum quantity:  $\geq 10.000$  St. / pcs.  
Bestell-Nr. / Ref. No.: 932899

## Druckflächen (in mm) Imprint positions (in mm)

### Siebdruck / Screen printing

S2: 55 x 15, S8: 12 x 29,5

### Tampondruck / Pad printing

T9: 7 x 7, T10: 8 x 9

### Digitaldruck / Digital printing

D19: 70 x 7 (9), D20: 70 x 7 (9), D21: 70 x 7

### Filmtransfer / Film transfer printing

—

### Gravur / Engraving

—



Update

# Loox

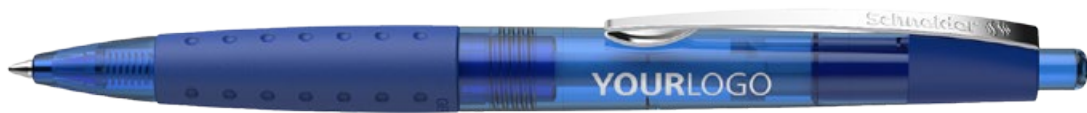

#### Mine/Refill 774 M

Eine Bestückung mit anderer Mine ist auf Anfrage möglich.  
Can be equipped with other refills upon request.

Druckkugelschreiber aus transparentem, opakem oder metallischem Kunststoff mit glänzender Oberfläche. Rutschfest gummierte Griffzone und Clip aus stabilem Edelstahl. Ausgestattet mit Schneider-Mine 774 M.

Retractable ballpoint pen in transparent, metallic or opaque plastics with shiny surface. Rubberised anti-slip grip zone and sturdy clip in stainless steel. Equipped with Schneider refill 774 M.

Klimaneutral hergestellt.

Produced climate neutrally.

## Mix & Match

Mit dem ausgeklügelten Prinzip Mix & Match können mehrere Farben miteinander kombiniert werden.  
With the ingenious "Mix & Match" principle, several colours can be combined with each other.



## Farben Colours

**Verfügbar ab / Available from:**    ≥300    ≥300    ≥300    ≥300    ≥1.000 St. / pcs.  
St. / pcs.    St. / pcs.    St. / pcs.    St. / pcs.    935599

**Bestell-Nr. / Ref. No.:**    935502    935503    935504    935501

**Farbauswahl / Select colour:**

	M24	M32	M6	M14	O70	O10	M24	M32	M6	M14	T65	T25	T34	T44	T10	
Druckknopf / Push button	M24	M32	M6	M14	O70	O10	M24	M32	M6	M14	T65	T25	T34	T44	T10	
Cliphülse / Clip sleeve	O13	O13	O13	O13	O70	O12	O13	O10			O65	O25	O34	O44	O10	
Oberteil / Upper part																
Vorderteil / Front part	M24	M32	M6	M14	O70	O10	M24	M32	M40	M14	T65	T25	T34	T44	T10	
	M24/ G13	M32/ G13	M6/ G13	M14/ G13	O70/ G70	O70/ G10	O10/ G10	M24/ G13	M32/ G13	M40/ G13	M14/ G13	T65/ G65	T25/ G25	T34/ G34	T44/ G44	T10/ G10

Mine / Refill:



Sondergehäusefarbe auf Anfrage / Special colours for pen body upon request

Mindestmenge / Minimum quantity: ≥10.000 St. / pcs.

Bestell-Nr. / Ref. No.: 935599

## Druckflächen (in mm) Imprint positions (in mm)

### Siebdruck / Screen printing

S2.1: 42 × 14, S2.2: 42 × 28 (≥ 1.000)

### Tampondruck / Pad printing

T8: 10 × 8

### Digitaldruck / Digital printing

### Filmtransfer / Film transfer printing

F2: 58,5, 360° (≥ 10.000)

### Gravur / Engraving





# Loox Promo



#### Mine/Refill 774 M

Eine Bestückung mit anderer Mine ist auf Anfrage möglich.  
Can be equipped with other refills upon request.

Druckkugelschreiber aus transparentem, opakem oder metallischem Kunststoff mit glänzender Oberfläche. Rutschfest gummierte Griffzone. Ausgestattet mit Schneider-Mine 774 M.

Retractable ballpoint pen in transparent, metallic or opaque plastics with shiny surface. Rubberised anti-slip grip zone. Equipped with Schneider refill 774 M.

Klimaneutral hergestellt.

Produced climate neutrally.



## Mix & Match

Mit dem ausgeklügelten Prinzip Mix & Match können mehrere Farben miteinander kombiniert werden.  
With the ingenious "Mix & Match" principle, several colours can be combined with each other.



## Farben Colours

Verfügbar ab /  
Available from:  $\geq 1.000$  St. / pcs.  
Bestell-Nr. / Ref. No.: 935799

Farbauswahl / Select colour:

	O70	O10	M24	M32	M40	M14	T65	T25	T34	T44	T10	
Druckknopf / Push button	O70	O10	M24	M32	M40	M14	T65	T25	T34	T44	T10	
Cliphülse / Clip sleeve	O70	O10					O65	O25	O34	O44	O10	
Oberteil / Upper part	O70	O10	M24	M32	M40	M14	T65	T25	T34	T44	T10	
Vorderteil / Front part	O70	O10	M24	M32	M40	M14	T65	T25	T34	T44	T10	
	O70/ G70	O70/ G10	O10/ G10	M24/ G13	M32/ G13	M40/ G13	M14/ G13	T65/ G65	T25/ G25	T34/ G34	T44/ G44	T10/ G10

Sondergehäusefarbe auf Anfrage / Special colours for pen body upon request  
Mindestmenge / Minimum quantity:  $\geq 10.000$  St. / pcs.  
Bestell-Nr. / Ref. No.: 935799

## Druckflächen (in mm) Imprint positions (in mm)

### Siebdruck / Screen printing

S2: 42 × 28

### Tampondruck / Pad printing

T4: 34 × 6, T8: 10 × 8

### Digitaldruck / Digital printing

### Filmtransfer / Film transfer printing

F2: 58,5, 360° ( $\geq 10.000$ )

### Gravur / Engraving



# Loox Metal



#### Mine/Refill 774 M

Eine Bestückung mit anderer Mine ist auf Anfrage möglich.  
Can be equipped with other refills upon request.

Druckkugelschreiber aus Kunststoff mit hochwertiger glänzender Silberlackierung und einer rutschfest gummierten Griffzone. Clip aus stabilem Edelstahl. Ausgestattet mit Schneider-Mine 774 M.

Retractable ballpoint pen in high-quality plastics with shiny silver lacquering and rubberised anti-slip grip zone. Sturdy clip of stainless steel. Equipped with Schneider refill 774 M.

Klimaneutral hergestellt.  
Produced climate neutrally.

## Mix & Match

Mit dem ausgeklügelten Prinzip Mix & Match können mehrere Farben miteinander kombiniert werden.  
With the ingenious "Mix & Match" principle, several colours can be combined with each other.



## Farben Colours

### Verfügbar ab /

Available from:  $\geq 1.000$  St. / pcs.

Bestell-Nr. / Ref. No.: 935299

### Farbauswahl / Select colour:

Druckknopf /  
Push button



Cliphülse /  
Clip sleeve



Oberteil /  
Upper part



Vorderteil /  
Front part



Sondergehäusefarbe auf Anfrage / Special colours for pen body upon request  
Mindestmenge / Minimum quantity:  $\geq 10.000$  St. / pcs.  
Bestell-Nr. / Ref. No.: 935299

## Druckflächen (in mm) Imprint positions (in mm)

### Siebdruck / Screen printing

S2: 42 × 28

### Tampondruck / Pad printing

T8: 10 × 8

### Digitaldruck / Digital printing

### Filmtransfer / Film transfer printing

### Gravur / Engraving



# K 15



## Mine/Refill 770 M

Eine Bestückung mit anderer Schreibfarbe ist auf Anfrage möglich.  
Can be equipped with other ink colour upon request.

Druckkugelschreiber aus opakem Kunststoff mit glänzender Oberfläche. Clip, Zierring und Druckknopf aus Metall.  
Ausgestattet mit Schneider-Mine 770 M.

Retractable ballpoint pen in opaque plastics with shiny surface. Clip, decorative ring and push button in metal.  
Equipped with Schneider refill 770 M.

Klimaneutral hergestellt.  
Produced climate neutrally.

# Inspiration



## Farben Colours

<b>Verfügbar ab / Available from:</b>	≥ 1.000	≥ 1.000	≥ 1.000	≥ 1.000	≥ 1.000	≥ 1.000	≥ 1.000	≥ 1.000	≥ 1.000	≥ 1.000	≥ 2.500
<b>St. / pcs.</b>	St. / pcs.	St. / pcs.	St. / pcs.	St. / pcs.	St. / pcs.	St. / pcs.	St. / pcs.	St. / pcs.	St. / pcs.	St. / pcs.	St. / pcs.
<b>Bestell-Nr. / Ref. No.:</b>	93088	93085	93086	930809	93082	930810	93083	93087	930804	93081	930899

### Farbauswahl / Select colour:

Oberteil /  
Upper part

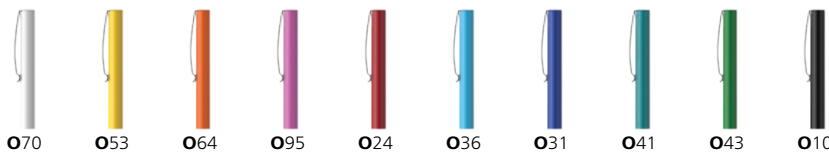

Freie Kombinationsmöglichkeit der links aufgeführten Teile / Free configuration of the items listed on the left-hand side

Vorderteil /  
Front part



Mine / Refill:



Sondergehäusefarbe auf Anfrage / Special colours for pen body upon request  
Mindestmenge / Minimum quantity: ≥ 10.000 St. / pcs.  
Bestell-Nr. / Ref. No.: 930899

## Druckflächen (in mm) Imprint positions (in mm)

### Siebdruck / Screen printing

S2.1: 52 × 12 (≥ 1.000), S2.2: 52 × 20 (≥ 2.500), S3: 20 × 26,5, S8: 18 × 26,5

### Tampondruck / Pad printing

—

### Digitaldruck / Digital printing

—

### Filmtransfer / Film transfer printing

—

### Gravur / Engraving

—



# Frosty



## Mine/Refill 774 M

Eine alternative Bestückung mit Mine 778 XB ist auf Anfrage möglich.  
Can alternatively be equipped with refill 778 XB upon request.

Druckkugelschreiber aus transparentem Kunststoff mit gefrosteter Oberfläche. Clip, Zierring und Druckknopf aus Metall.  
Ausgestattet mit Schneider-Mine 774 M.

Retractable ballpoint pen in transparent plastics with frosted surface. Clip, decorative ring and push button in metal.  
Equipped with Schneider refill 774 M.

Klimaneutral hergestellt.  
Produced climate neutrally.

# Inspiration



## Farben Colours

<b>Verfügbar ab / Available from:</b>	≥ 1.000 St. / pcs.	≥ 1.000 St. / pcs.	≥ 1.000 St. / pcs.	≥ 1.000 St. / pcs.	≥ 1.000 St. / pcs.	≥ 1.000 St. / pcs.	≥ 1.000 St. / pcs.
<b>Bestell-Nr. / Ref. No.:</b>	931949	931905	931906	931902	931903	931904	931901

≥ 2.500 St. / pcs.  
931999

### Farbauswahl / Select colour:

Oberteil /  
Upper part



Vorderteil /  
Front part



Mine / Refill:



Sondergehäusefarbe auf Anfrage / Special colours for pen body upon request  
Mindestmenge / Minimum quantity: ≥ 10.000 St. / pcs.  
Bestell-Nr. / Ref. No.: 931999

Freie Kombinationsmöglichkeit  
der links aufgeführten Teile /  
Free configuration of the items  
listed on the left-hand side

## Druckflächen (in mm) Imprint positions (in mm)

### Siebdruck / Screen printing

S2.1: 52 × 12 (≥ 1.000), S2.2: 52 × 20 (≥ 2.500), S3: 20 × 26,5, S8: 18 × 26,5

### Tampondruck / Pad printing

### Digitaldruck / Digital printing

### Filmtransfer / Film transfer printing

### Gravur / Engraving

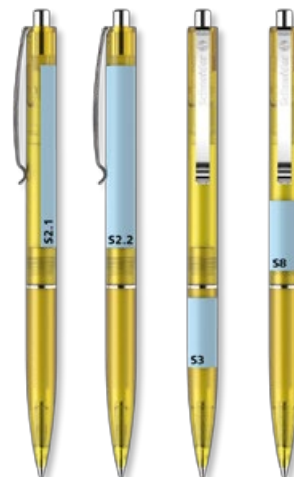

# Office



**Mine/Refill 770 M**

Eine Bestückung mit anderer Mine ist auf Anfrage möglich.  
Can be equipped with other refills upon request.

Druckkugelschreiber aus opakem Kunststoff mit glänzender Oberfläche. Clip, Zierring und Druckknopf aus Metall.  
Ausgestattet mit Schneider-Mine 770 M.

Retractable ballpoint pen in opaque plastics with shiny surface. Clip, decorative ring and push button in metal.  
Equipped with Schneider refill 770 M.

*Klimaneutral hergestellt.  
Produced climate neutrally.*



# Inspiration



## Farben Colours

<b>Verfügbar ab / Available from:</b>	≥ 1.000	≥ 1.000	≥ 1.000	≥ 1.000	≥ 1.000	≥ 1.000	≥ 2.500
<b>St. / pcs.</b>	St. / pcs.	St. / pcs.	St. / pcs.	St. / pcs.	St. / pcs.	St. / pcs.	St. / pcs.
<b>Bestell-Nr. / Ref. No.:</b>	932949	932905	932902	932903	932904	932901	932999

### Farbauswahl / Select colour:

Oberteil /  
Upper part



Vorderteil /  
Front part



Mine / Refill:



Freie Kombinationsmöglichkeit  
der links aufgeführten Teile /  
Free configuration of the items  
listed on the left-hand side

Sondergehäusefarbe auf Anfrage / Special colours for pen body upon request  
Mindestmenge / Minimum quantity: ≥ 10.000 St. / pcs.  
Bestell-Nr. / Ref. No.: 932999

## Druckflächen (in mm) Imprint positions (in mm)

### Siebdruck / Screen printing

S2.1: 50 × 14 (≥ 1.000), S2.2: 40 × 28 (≥ 2.500)

### Tampondruck / Pad printing

T8: 10 × 8

### Digitaldruck / Digital printing

—

### Filmtransfer / Film transfer printing

—

### Gravur / Engraving

—



# Sunlite



#### Mine/Refill 774 M

Eine Bestückung mit anderer Mine ist auf Anfrage möglich.  
Can be equipped with other refills upon request.

Druckkugelschreiber aus transparentem Kunststoff mit glänzender Oberfläche. Clip, Zierring und Druckknopf aus Metall.  
Ausgestattet mit Schneider-Mine 774 M.

Retractable ballpoint pen in transparent plastics with shiny surface. Clip, decorative ring and push button in metal.  
Equipped with Schneider refill 774 M.

Klimaneutral hergestellt.  
Produced climate neutrally.

# Inspiration



## Farben Colours

<b>Verfügbar ab / Available from:</b>	≥ 1.000 St. / pcs.	≥ 1.000 St. / pcs.	≥ 1.000 St. / pcs.	≥ 1.000 St. / pcs.	≥ 1.000 St. / pcs.	≥ 1.000 St. / pcs.	≥ 1.000 St. / pcs.	≥ 2.500 St. / pcs.
<b>Bestell-Nr. / Ref. No.:</b>	936649	936605	936606	936602	936603	936604	936601	936699

**Farbauswahl / Select colour:**

Oberteil /  
Upper part



Vorderteil /  
Front part



Mine / Refill:



Freie Kombinationsmöglichkeit der links aufgeführten Teile / Free configuration of the items listed on the left-hand side

Sondergehäusefarbe auf Anfrage / Special colours for pen body upon request  
Mindestmenge / Minimum quantity: ≥ 10.000 St. / pcs.  
Bestell-Nr. / Ref. No.: 936699

## Druckflächen (in mm) Imprint positions (in mm)

### Siebdruck / Screen printing

S2.1: 50 × 14 (≥ 1.000), S2.2: 40 × 28 (≥ 2.500)

### Tampondruck / Pad printing

T8: 10 × 8

### Digitaldruck / Digital printing

—

### Filmtransfer / Film transfer printing

—

### Gravur / Engraving

—

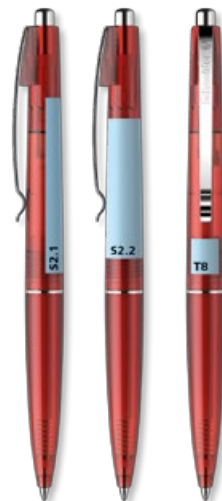

# Tops Promo



Schreibfarben/Writing colours

Kappen-Kugelschreiber aus transparentem oder opakem Kunststoff mit glänzender Oberfläche.  
Verschleißfeste Schreibspitze (M) aus Edelstahl.

Capped ballpoint pen available in transparent or opaque plastics with shiny surface. Wear-resistant stainless steel tip (M).

*Klimaneutral hergestellt.  
Produced climate neutrally.*

# Inspiration



## Farben Colours

<b>Verfügbar ab / Available from:</b>	≥2.500 St. / pcs.	≥2.500 St. / pcs.	≥2.500 St. / pcs.	≥2.500 St. / pcs.	≥10.000 St. / pcs.
<b>Bestell-Nr. / Ref. No.:</b>	951582	951583	951584	951581	951599

### Farbauswahl / Select colour:

Kappe / Cap										
	T71	T71	T71	T71	T71					
Stopfen / Plug										
	T71	T71	T71	T71	T71					
Schaft / Barrel										
	T25	T34	T47	T10	T50	T62	T25	T34	T47	T10
Spitze / Tip										
	O70	O70	O70	O70	O70					
Mine / Refill:										

Sondergehäusefarbe auf Anfrage / Special colours for pen body upon request  
Mindestmenge / Minimum quantity: ≥10.000 St. / pcs.  
Bestell-Nr. / Ref. No.: 951599

## Druckflächen (in mm) Imprint positions (in mm)

### Siebdruck / Screen printing

S1.1: 65 × 24 (≥ 2.500, 1C), S1.2: 80 × 24 (≥ 10.000, 4C)

### Tampondruck / Pad printing

—

### Digitaldruck / Digital printing

—

### Filmtransfer / Film transfer printing

F1: 98, 360° (≥ 10.000)

### Gravur / Engraving

—

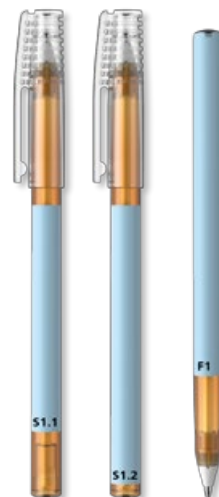

”

**Regional ist keine Strategie,  
sondern eine Einstellung – bis hin  
zum Kugelschreiber an der Kasse.**

Regional is not a strategy,  
it's an attitude - all the way to  
the ballpoint pen at the register.



# Universal- Halierung

Universal Holders





# Universal-Halterung

## Universal Holders



Soft Touch



Mix & Match



Biobasierter Kunststoff / Bio-based plastics



Recycling-Kunststoff / Recycled plastics



Preiskategorie € / Price Category €



Preiskategorie €€ / Price Category €€



Preiskategorie €€€ / Price Category €€€



Preiskategorie €€€€ / Price Category €€€€





114 Klick-Fix-Pen Promo



116 Klick-Fix

# Klick-Fix-Pen Promo



## Mine/Refill 774 M

Eine Bestückung mit anderer Mine ist auf Anfrage möglich.  
Can be equipped with other refills upon request.

Kugelschreiber mit Teleschnur zur Befestigung an Kasse, Telefon, im Auto etc. Der Klick-Fix ist selbstklebend, die Klemmböden können in jede gewünschte Position gedreht werden. Ausgestattet mit Schneider-Mine 774 M.

Ballpoint pen with expandable cord for fastening at the cash desk, phone, in the car etc. The Klick-Fix is auto adhesive, and the clamps can be rotated to any position. Equipped with Schneider refill 774 M.

*Klimaneutral hergestellt.*

*Produced climate neutrally.*

## Inspiration



## Farben Colours

Verfügbar ab /  
Available from:

≥ 100 St. / pcs.

Bestell-Nr. / Ref. No.: 941349 941305 941302 941303 941304 941301 941356 941355 941352 941353 941354 941351

Stift /  
Pen



070/  
070 070/  
051 070/  
025 070/  
034 070/  
043 070/  
010 010/  
070 010/  
051 010/  
025 010/  
034 010/  
043 010/  
010

Klick-Fix



070/  
070 070/  
051 070/  
025 070/  
034 070/  
043 070/  
010 010/  
070 010/  
051 010/  
025 010/  
034 010/  
043 010/  
010

Mine / Refill:



Eine Bestückung mit anderer Mine ist möglich / Can be equipped with other refills  
Mindestmenge / Minimum quantity: ≥ 1.000 St. / pcs.  
Bestell-Nr. / Ref. No.: 941399

## Druckflächen (in mm) Imprint positions (in mm)

Siebdruck / Screen printing

S2: 55 × 29

Tampondruck / Pad printing

T18.1: 3, T18.2: 3

Digitaldruck / Digital printing

D2: 78 × 7

Filmtransfer / Film transfer printing

—

Gravur / Engraving

—



# Klick-Fix



Universeller Halter für Stifte, Marker, Computerzubehör etc. - im Prinzip für sämtliche kleinere Produkte. Der Klick-Fix ist auf der Rückseite selbstklebend, die Klemmbaken können in jede gewünschte Position gedreht werden. Der Klick-Fix kann auf vielen Oberflächen angebracht werden. Er ist individualisierbar und einfach praktisch.

Universal holder for pens, markers, computer tools, etc. - virtually any small product. The Klick-Fix has an adhesive back and the clamps can be rotated to any position. The back panel can be stuck to multiple surfaces. Customize your component colors! The Klick-Fix can be customized with your name or expression. Handy, anywhere you place it.

Klimaneutral hergestellt.

Produced climate neutrally.

# Inspiration



## Farben Colours

Verfügbar ab /

Available from:  $\geq 100$  St. / pcs.

Bestell-Nr. / Ref. No.: 941149 941105 94122 94123 941104 941101 941156 941155 941152 941153 941154 941151

Klemmbacken /  
Clamps



070



051



025



034



043



010



070



051



025



034



043



010

Deckplatte /  
Cover plate



070



070



070



070



070



070



010



010



010



010



010



010

## Druckflächen (in mm) Imprint positions (in mm)

Siebdruck / Screen printing

—

Tampondruck / Pad printing

T18.1: 3, T18.2: 3

Digitaldruck / Digital printing

—

Filmtransfer / Film transfer printing

—

Gravur / Engraving

—



”

Das Highlight jeder  
Veranstaltung: ein Give-away,  
das man zu Hause gern  
wieder in die Hand nimmt.

The highlight of every event: the  
free gift that you can take home  
with you.



# Textmarker

Highlighters





# Textmarker

## Highlighters



Soft Touch



Mix & Match



Biobasierter Kunststoff / Bio-based plastics



Recycling-Kunststoff / Recycled plastics

1

Preiskategorie € / Price Category €

2

Preiskategorie €€ / Price Category €€

3

Preiskategorie €€€ / Price Category €€€

4

Preiskategorie €€€€ / Price Category €€€€





122 Link-It Highlighter



2

3



1 124 Highlighter 180



1 126 Highlighter 150



1 128 Highlighter 177





[www.blauer-engel.de/uz200](http://www.blauer-engel.de/uz200)



# Link-It Highlighter



Tintenfarben/Ink colors



Click! Das erste modulare System, das zwei Stifte clever verlinkt. Ausgezeichnet mit dem weltweit bekanntesten Umweltzeichen "Blauer Engel". Keilspitze für 1+4 mm.

Click! The first modular system that cleverly links two pens. Awarded with the world's best-known eco-label "Blue Angel". Chisel tip for line widths 1+4 mm.

\*Gehäuse aus > 85% biobasiertem Kunststoff. Klimaneutral hergestellt.

\*Pen body made of > 85% biobased plastic. Produced climate neutrally.



# Inspiration



## Farben Colours

### Link-It Highlighter

**4er-Stiftebox /  
Pencil case of 4**  
**Verfügbar ab /  
Available from:** ≥ 100 St. / pcs.  
**Bestell-Nr. / Ref. No.:** 919294

Kappe /  
Cap

Schaft /  
Barrel



O90



G15/  
O70



O63



G15/  
O70



O54



G15/  
O70



O47



G15/  
O70



Tinte / Ink:

**2er-Set /  
Set of 2**

≥ 300 St. / pcs.  
919230

2 Stifte aus den  
links vordefinierten  
Kombinationen /  
2 pens of the  
predefined com-  
binations on the  
left-hand side

### Verschiedene Link-It Schreibsysteme / Combine different Link-It writing systems:

8er-Stiftebox / Pencil case of 8	4er-Stiftebox / Pencil case of 4	2er-Set / Set of 2
≥ 100 St. / pcs. 942098	≥ 100 St. / pcs. 942094	≥ 300 St. / pcs. 942092

8                      4                      2  
... Stifte aus den vordefinierten Kombinationen des Link-It Sliders, Link-It Fineliners und Link-It Highlighters /  
... pens of the predefined combinations of Link-It Slider, Link-It Fineliner and Link-It Highlighter

Die Fineliner- und Textmarkerausführungen dieses Produkts sind in den vordefinierten Basisvarianten mit dem Blauen Engel zertifiziert. Produktänderungen und -veredelungen jeglicher Art hätten die Notwendigkeit eines neuen Validierungsprozesses zur Folge. Aus diesem Grund tragen die Produkte nur in den von uns angebotenen Basisausführungen unbedruckt das Logo „Blauer Engel“. / The fineliner and highlighter versions of this product are certified with the Blue Angel in their predefined basic variants. Product modifications and refinements of any kind require a new validation process if the certificate is to be upheld. For this reason, the products only bear the „Blue Angel“ logo in their basic versions, unprinted.

## Druckflächen (in mm) Imprint positions (in mm)

Siebdruck / Screen printing

Tampondruck / Pad printing

Digitaldruck / Digital printing

D1.1: 22 × 5,5, D1.2: 27,5 × 5,5, D16: 60 × 10 / 106 × 10,  
D17: 43 × 9 / 87 × 9

Filmtransfer / Film transfer printing

Gravur / Engraving





reddot design award  
winner 2013

# Highlighter 180



#### Tintenfarben/Ink colors

Folgende Sondertintenfarben sind auf Anfrage erhältlich.  
The following special writing colours are available upon request.



Textmarker aus opakem Kunststoff mit fein mattierter Oberfläche. Leuchtstarke, lichtbeständige Tinte. Für Normal-, Copy- und Faxpapier. Keilspitze 1+5 mm.

Highlighter in opaque plastics with matt surface. Vivid and light proof ink suitable for normal, copy and fax paper. Chisel tip for 1+5 mm.

*Klimaneutral hergestellt.  
Produced climate neutrally.*

# Inspiration



## Farben Colours

### Verfügbar ab /

Available from:  $\geq 600$  St. / pcs.

Bestell-Nr. / Ref. No.: 918005

$\geq 600$  St. / pcs.  
918006

$\geq 600$  St. / pcs.  
918009

$\geq 600$  St. / pcs.  
918004

Kappe /  
Cap



O54



O63



O90



O47

Schaft /  
Barrel



O10



O10



O10



O10

Vorderteil /  
Front part



O54



O63



O90



O47

Tinte / Ink:



Sondergehäusefarbe auf Anfrage / Special colours for pen body upon request  
Mindestmenge / Minimum quantity:  $\geq 10.000$  St. / pcs.  
Bestell-Nr. / Ref. No.: 918099

## Druckflächen (in mm) Imprint positions (in mm)

### Siebdruck / Screen printing

—

### Tampondruck / Pad printing

T1: 48 x 14

### Digitaldruck / Digital printing

D1: 65 x 18,4

### Filmtransfer / Film transfer printing

—

### Gravur / Engraving

—



# Highlighter 150

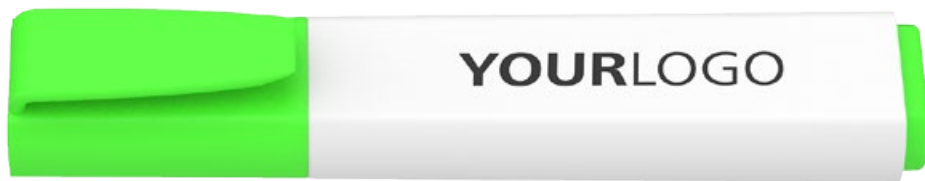

Tintenfarben/Ink colors

Textmarker aus opakem Kunststoff mit fein mattierter Oberfläche. Leuchtstarke, lichtbeständige Tinte. Für Normal-, Copy- und Faxpapier. Keilspitze 1+5 mm.

Highlighter in opaque plastics with matt surface. Vivid and light proof ink suitable for normal, copy and fax paper. Chisel tip for 1+5 mm.

*Klimaneutral hergestellt.  
Produced climate neutrally.*

# Inspiration

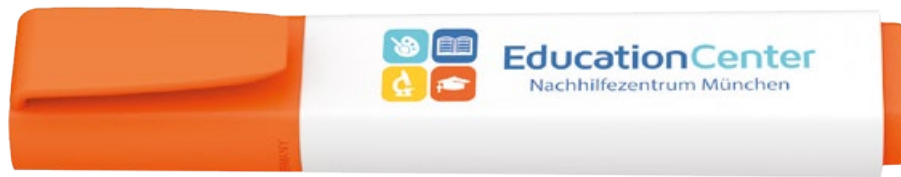

## Farben Colours

### Verfügbar ab /

Available from:  $\geq 600$  St. / pcs.

Bestell-Nr. / Ref. No.: 915005

Kappe /  
Cap



O54

Stopfen /  
Plug



O54

Schaft /  
Barrel



O70

Tinte / Ink:



$\geq 600$  St. / pcs.

915006



O63



O63



O70



$\geq 600$  St. / pcs.

915009



O90



O90



O70



$\geq 600$  St. / pcs.

915004



O47



O47



O70



Sondergehäusefarbe auf Anfrage / Special colours for pen body upon request  
Mindestmenge / Minimum quantity:  $\geq 10.000$  St. / pcs.  
Bestell-Nr. / Ref. No.: 915098

## Druckflächen (in mm) Imprint positions (in mm)

### Siebdruck / Screen printing

—

### Tampondruck / Pad printing

T1: 60 × 14, T4: 20 × 10

### Digitaldruck / Digital printing

D1: 76 × 17

### Filmtransfer / Film transfer printing

—

### Gravur / Engraving

—

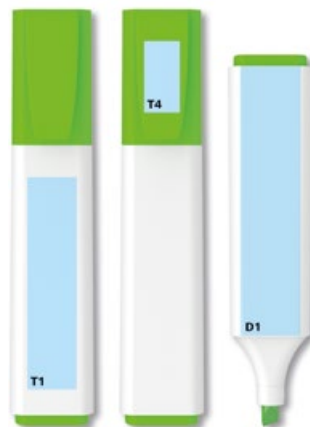

# Highlighter 177



Tintenfarben/Ink colors

Textmarker aus transparentem Kunststoff mit fein mattierter Oberfläche. Leuchtstarke, lichtbeständige Tinte. Für Normal-, Copy- und Faxpapier. Keilspitze 1+5 mm.

Highlighter in transparent plastics with matt surface. Vivid and light proof ink suitable for normal, copy and fax paper. Chisel tip for 1+5 mm.

*Klimaneutral hergestellt.*

*Produced climate neutrally.*



# Inspiration



## Farben Colours

### Verfügbar ab /

Available from:  $\geq 600$  St. / pcs.

Bestell-Nr. / Ref. No.: 917705

Kappe /  
Cap



T54

Stopfen /  
Plug



T54

Schaft /  
Barrel



T54

Tinte / Ink:



$\geq 600$  St. / pcs.

917702



T25



T25



T25



$\geq 600$  St. / pcs.

917703



T34



T34



T34



$\geq 600$  St. / pcs.

917704



T47



T47



T47



Sondergehäusefarbe auf Anfrage / Special colours for pen body upon request  
Mindestmenge / Minimum quantity:  $\geq 10.000$  St. / pcs.  
Bestell-Nr. / Ref. No.: 917799

## Druckflächen (in mm) Imprint positions (in mm)

### Siebdruck / Screen printing

—

### Tampondruck / Pad printing

T1: 60 × 14, T4: 20 × 10

### Digitaldruck / Digital printing

D1: 76 × 17

### Filmtransfer / Film transfer printing

—

### Gravur / Engraving

—

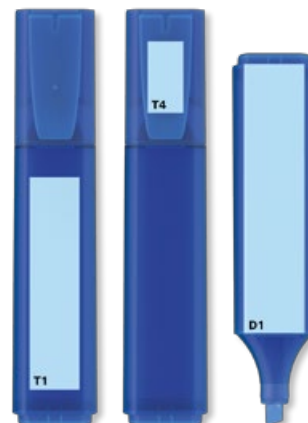

”

**Darauf ist Verlass: auf ein überzeugendes Unternehmen. Gut zu wissen, dass das auch für seine Werbemittel gilt.**

Something you can rely on: a convincing company.

Good to know that this also applies to its

promotional products

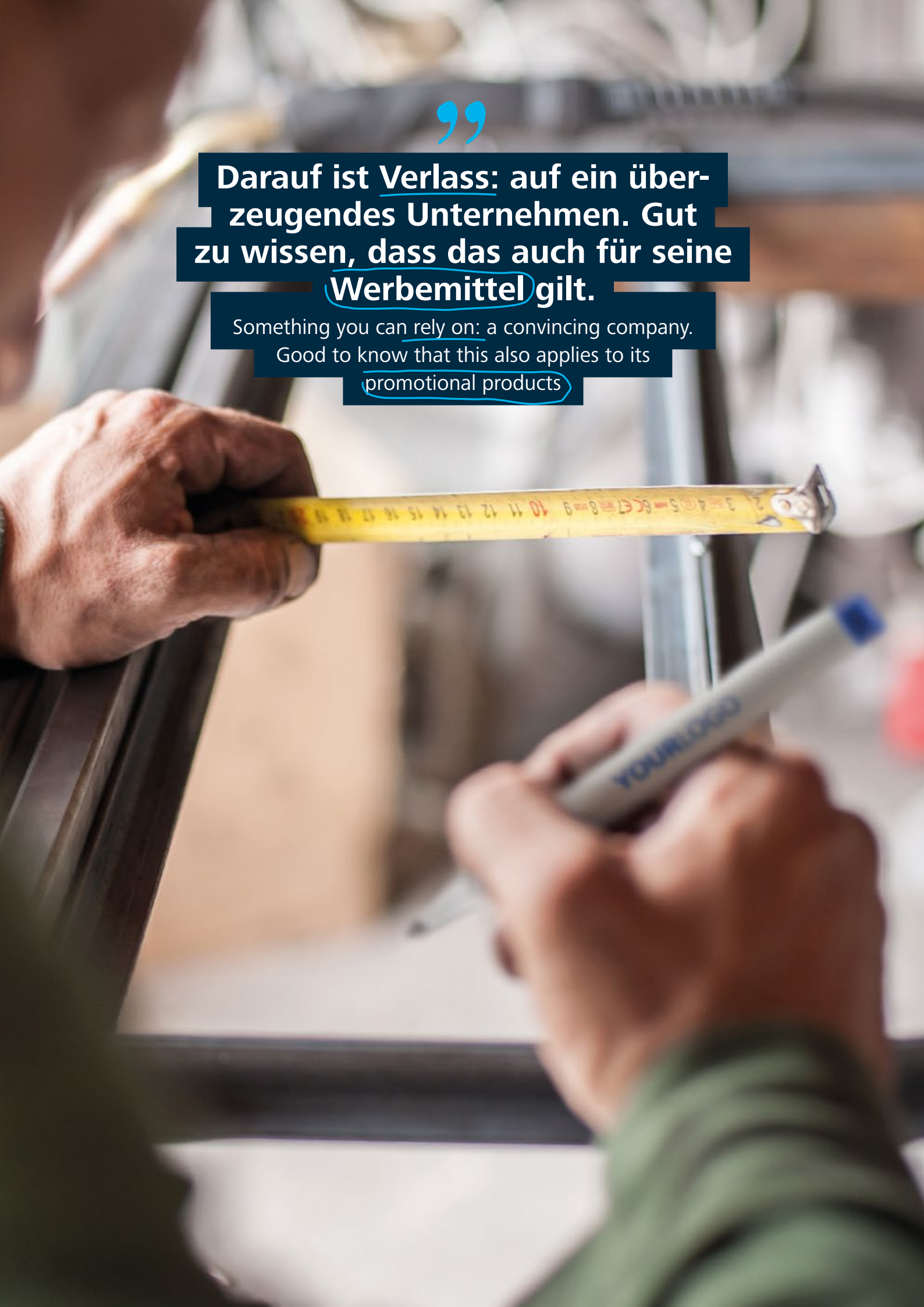

# Permanent Marker

Permanent Markers





# Permanent Marker

## Permanent Markers



Soft Touch



Mix & Match



Biobasierter Kunststoff / Bio-based plastics



Recycling-Kunststoff / Recycled plastics



Preiskategorie € / Price Category €



Preiskategorie €€ / Price Category €€



Preiskategorie €€€ / Price Category €€€



Preiskategorie €€€€ / Price Category €€€€



134 Permanent Marker 130



136 Universal Marker 224



# Permanent Marker 130



Tintenfarben/Ink colors

Permanent Marker aus opakem Kunststoff mit glänzender Oberfläche. Für Karton, Papier, Kunststoff, Glas, Metall und Holz. Wasserfest, lichtbeständig, schnelltrocknend. Cap off-Tinte, kann 2–3 Tage offen liegen. Rundspitze 1–3 mm.

Permanent marker in opaque plastics with shiny surface. For carton, paper, plastics, glass, metal and wood. Quick-drying, light and water resistant. Cap-off ink, can be kept open 2 to 3 days. Rounded tip for 1–3 mm.

*\*Gehäuse zu 95 % aus Recycling-Kunststoff. Klimaneutral hergestellt.*













*\*Pen body made of 95% recycled plastic. Produced climate neutrally.*



# Inspiration



## Farben Colours

Verfügbar ab / Available from:	≥ 600 St. / pcs.	≥ 600 St. / pcs.	≥ 600 St. / pcs.
Bestell-Nr. / Ref. No.:	913001	913101	913103
Kappe / Cap			
Stopfen / Plug			
Schaft / Barrel			
Tinte / Ink:			

Sondergehäusefarbe auf Anfrage / Special colours for pen body upon request  
Mindestmenge / Minimum quantity: ≥ 10.000 St. / pcs.  
Bestell-Nr. / Ref. No.: 913099

## Druckflächen (in mm) Imprint positions (in mm)

### Siebdruck / Screen printing

S1: 75 × 43

### Tampondruck / Pad printing

—

### Digitaldruck / Digital printing

—

### Filmtransfer / Film transfer printing

F1: 92, 360° (≥ 10.000)

### Gravur / Engraving

—

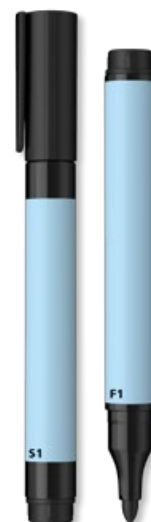

# Universal Marker 224



Tintenfarben/Ink colors

Universal-Marker aus schwarz-opakem Kunststoff mit glänzender Oberfläche. Für OHP-Folie, CD + DVD, Karton, Papier, Kunststoff, Glas, Metall und Holz. Wasserfest, lichtbeständig, schnelltrocknend. Cap off-Tinte, kann 2–3 Tage offen liegen. Rundspitze 1 mm.

Universal marker in opaque plastics with shiny surface. For OHP film, CD and DVD, carton, paper, plastics, glass, metal and wood. Quick-drying, light and water resistant. Cap-off ink, can be kept open 2 to 3 days. Rounded tip for 1 mm.

Klimaneutral hergestellt.

Produced climate neutrally.



# Inspiration



## Farben Colours

**Verfügbar ab /**  
**Available from:** ≥ 1.000 St. / pcs.  
**Bestell-Nr. / Ref. No.:** 922401



Sondergehäusefarbe auf Anfrage / Special colours for pen body upon request  
Mindestmenge / Minimum quantity: ≥ 10.000 St. / pcs.  
Bestell-Nr. / Ref. No.: 922499

## Druckflächen (in mm) Imprint positions (in mm)

### Siebdruck / Screen printing

S1: 65 × 31,5

### Tampondruck / Pad printing

T4: 30 × 7

### Digitaldruck / Digital printing

### Filmtransfer / Film transfer printing

F1: 87, 360° (≥ 10.000)

### Gravur / Engraving





”

**Standard ist etwas für den Durchschnitt. Es ist das Besondere, zu dem man gern wieder und wieder greift.**

Standard is for the mainstream.  
It is that something special that one likes to use again and again.

# Fineliner

Fineliners





# Fineliner

---

## Fineliners



Soft Touch



Mix & Match



Biobasierter Kunststoff / Bio-based plastics



Recycling-Kunststoff / Recycled plastics



Preiskategorie € / Price Category €



Preiskategorie €€ / Price Category €€



Preiskategorie €€€ / Price Category €€€



Preiskategorie €€€€ / Price Category €€€€



142 Link-It Fineliner



144 Line-Up



146 Topliner 963 Recycling



148 Topliner 967 Recycling





[www.blauer-engel.de/uz200](http://www.blauer-engel.de/uz200)



GERMAN  
DESIGN  
AWARD  
WINNER  
2020



# Link-It Fineliner

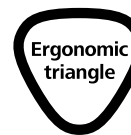

Tintenfarben/Ink colors



Click! Das erste modulare System, das zwei Stifte clever verlinkt. Ausgezeichnet mit dem weltweit bekanntesten Umweltzeichen "Blauer Engel". Fineliner, Strichstärke 0,4 mm. Cap Off-Tinte, kann 2-3 Tage offen bleiben.

Click! The first modular system that cleverly links two pens. Awarded with the world's best-known eco-label "Blue Angel". Fineliner, line width 0.4 mm. Cap-off ink does not run dry even if the cap is removed for 2-3 days.

\*Gehäuse aus > 85% biobasiertem Kunststoff. Klimaneutral hergestellt.

\*Pen body made of > 85% biobased plastic. Produced climate neutrally.



# Inspiration



## Farben Colours

	Link-It Fineliner								Verschiedene Link-It Schreibsysteme / Combine different Link-It writing systems:					
	8er-Stiftebox / Pencil case of 8								4er-Stiftebox / Pencil case of 4	2er-Set / Set of 2	8er-Stiftebox / Pencil case of 8	4er-Stiftebox / Pencil case of 4	2er-Set / Set of 2	
<b>Verfügbar ab / Available from:</b>	≥ 100 St. / pcs.								≥ 100 St. / pcs.	≥ 300 St. / pcs.	≥ 100 St. / pcs.	≥ 100 St. / pcs.	≥ 300 St. / pcs.	
<b>Bestell-Nr. / Ref. No.:</b>	991298								991294	991230	942098	942094	942092	
<b>Kappe / Cap</b>									Vordefinierte Kombinationen wie links (schwarz, rot, grün, blau) / Predefined combinations as on the left-hand side (black, red, green, blue)	2 Stifte aus den links vordefinierten Kombinationen / 2 pens of the predefined combinations on the left-hand side	8	4	2	
<b>Schaft / Barrel</b>											... Stifte aus den vordefinierten Kombinationen des Link-It Sliders, Link-It Fineliners und Link-It Highlighters / ... pens of the predefined combinations of Link-It Slider, Link-It Fineliner and Link-It Highlighter			
<b>Adapter / Adapter</b>														
<b>Tinte / Ink:</b>														

Die Fineliner- und Textmarkerausführungen dieses Produkts sind in den vordefinierten Basisvarianten mit dem Blauen Engel zertifiziert. Produktänderungen und -veredelungen jeglicher Art hätten die Notwendigkeit eines neuen Validierungsprozesses zur Folge. Aus diesem Grund tragen die Produkte nur in den von uns angebotenen Basisausführungen unbedruckt das Logo „Blauer Engel“. / The fineliner and highlighter versions of this product are certified with the Blue Angel in their predefined basic variants. Product modifications and refinements of any kind require a new validation process if the certificate is to be upheld. For this reason, the products only bear the „Blue Angel“ logo in their basic versions, unprinted.

## Druckflächen (in mm) Imprint positions (in mm)

Siebdruck / Screen printing

Tampondruck / Pad printing

Digitaldruck / Digital printing

D11: 22 x 5,5, D12: 27,5 x 5,5, D16: 60 x 10 / 106 x 10, D17: 43 x 9 / 87 x 9

Filmtransfer / Film transfer printing

Gravur / Engraving





[www.blauer-engel.de/uz200](http://www.blauer-engel.de/uz200)

# Line-Up



Tintenfarben / Ink colors



Fineliner mit einem Gehäuse aus biobasiertem Kunststoff. Ausgezeichnet mit dem weltweit bekanntesten Umweltzeichen "Blauer Engel". Stabile, metallgefasste Schreibspitze, Strichstärke 0,4 mm. Cap Off-Tinte, kann 2-3 Tage offen bleiben. Gummierter Dreiecksbarrel für entspanntes Schreiben. In 4 Farben verfügbar.

Fineliner with pen body made of biobased plastic. Awarded with the world's best-known eco-label "Blue Angel". Robust metal-encased writing tip, line width 0.4 mm. Cap-off ink does not run dry even if the cap is removed for 2-3 days. Rubberised triangular barrel for relaxed writing. Available in 4 colours.

*\*Gehäuse aus > 85% biobasiertem Kunststoff. Klimaneutral hergestellt.*

*\*Pen body made of > 85% biobased plastic. Produced climate neutrally.*





# Inspiration



## Farben Colours

	1 Stift / 1 pen	1 Stift / 1 pen	1 Stift / 1 pen	1 Stift / 1 pen	4er-Stiftebox / Pencil case of 4
<b>Verfügbar ab / Available from:</b>	≥ 300 St. / pcs. 991001	≥ 300 St. / pcs. 991002	≥ 300 St. / pcs. 991004	≥ 300 St. / pcs. 991003	≥ 100 St. / pcs. 991094
<b>Bestell-Nr. / Ref. No.:</b>					
Kappe / Cap	O10	O25	O43	O34	Vordefinierte Kombinationen wie links (schwarz, rot, grün, blau) / Predefined combinations as on the left- hand side (black, red, green, blue)
Schaft / Barrel					
Adapter / Adapter	G10/ O70 ↓ O10	G10/ O70 ↓ O25	G10/ O70 ↓ O43	G10/ O70 ↓ O34	
Tinte / Ink:	●	●	●	●	

Dieses Produkt ist in den vordefinierten Basisvarianten mit dem Blauen Engel zertifiziert. Produktänderungen und -veredelungen jeglicher Art hätten die Notwendigkeit eines neuen Validierungsprozesses zur Folge. Aus diesem Grund tragen die Produkte nur in den von uns angebotenen Basisausführungen unbedruckt das Logo „Blauer Engel“.  
This product is certified with the Blue Angel in its predefined basic variants. Product modifications and refinements of any kind require a new validation process if the certificate is to be upheld. For this reason, the products only bear the „Blue Angel“ logo in their basic versions, unprinted.

## Druckflächen (in mm) Imprint positions (in mm)

Siebdruck / Screen printing

Tampondruck / Pad printing

Digitaldruck / Digital printing

D1: 69 × 5,5, D16: 60 × 10, D17: 43 × 9

Filmtransfer / Film transfer printing

Gravur / Engraving



# Topliner 963 Recycling



#### Tintenfarben / Ink colors

Folgende Sondertintenfarben sind auf Anfrage erhältlich.  
The following special writing colours are available upon request.



Fineliner aus opakem Kunststoff mit fein mattierter Oberfläche. Cap off-Tinte, kann 2–3 Tage offen liegen.  
Metallclip und metallgefasste Faserspitze 0,4 mm.

Fineliner in opaque plastics with matt surface. Cap-off ink, can be kept open 2 to 3 days.  
Metal clip and metal-encased fibre tip 0.4 mm.

*\*Gehäuse zu > 85% aus Recycling-Kunststoff. Klimaneutral hergestellt.*

*\*Pen body made of > 85% recycled plastic. Produced climate neutrally.*



# Inspiration



## Farben Colours

### Verfügbar ab /

**Available from:**    ≥600 St. / pcs.    ≥600 St. / pcs.    ≥600 St. / pcs.    ≥600 St. / pcs.    ≥2.500 St. / pcs.

**Bestell-Nr. / Ref. No.:**    99636    99638    996301    996303    996399

### Farbauswahl / Select colour:

Kappe mit Kappenein-  
satz /  
Cap with cap insert



070/  
010

070/  
034

010/  
010

010/  
034

070/  
010

070/  
034

010/  
010

010/  
034

Stopfen /  
Plug



010

034

010

034

010

034

Schaft /  
Barrel



Adapter /  
Adapter



070

070

010

010

070

010

Tinte / Ink:



Sondergehäusefarbe auf Anfrage / Special colours for pen body upon request  
Mindestmenge / Minimum quantity: ≥10.000 St. / pcs.  
Bestell-Nr. / Ref. No.: 996399

## Druckflächen (in mm) Imprint positions (in mm)

### Siebdruck / Screen printing

S1: 58 × 28

### Tampondruck / Pad printing

—

### Digitaldruck / Digital printing

—

### Filmtransfer / Film transfer printing

—

### Gravur / Engraving

—

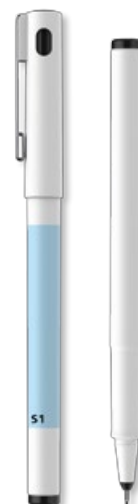



# Topliner 967 Recycling



#### Tintenfarben/Ink colors

Folgende Sondertintenfarben sind auf Anfrage erhältlich.  
The following special writing colours are available upon request.



Fineliner aus opakem Kunststoff mit fein mattierter Oberfläche. Cap off-Tinte, kann 2–3 Tage offen liegen.  
Metallgefasste Faserspitze 0,4 mm.

Fineliner in opaque plastics with matt surface. Cap-off ink, can be kept open 2 to 3 days. Metal-encased fibre tip 0.4 mm.

*\*Gehäuse zu > 85% aus Recycling-Kunststoff. Klimaneutral hergestellt.*

*\*Pen body made of > 85% recycled plastic. Produced climate neutrally.*



# Inspiration



## Farben Colours

Verfügbar ab / Available from:	≥ 600 St. / pcs.	≥ 600 St. / pcs.	≥ 600 St. / pcs.	≥ 600 St. / pcs.	≥ 2.500 St. / pcs.
Bestell-Nr. / Ref. No.:	996701	996703	996731	996733	996799

Farbauswahl / Select colour:

	070/ 010	070/ 034	010/ 010	010/ 034	070/ 010	070/ 034	010/ 010	010/ 034
Kappe mit Kappeneinsatz / Cap with cap insert								
Stopfen / Plug								
Schaft / Barrel								
Adapter / Adapter								
Tinte / Ink:	●	●	●	●	●	●	●	●

Sondergehäusefarbe auf Anfrage / Special colours for pen body upon request  
Mindestmenge / Minimum quantity: ≥ 10.000 St. / pcs.  
Bestell-Nr. / Ref. No.: 996799

## Druckflächen (in mm) Imprint positions (in mm)

### Siebdruck / Screen printing

S1: 58 × 28

### Tampondruck / Pad printing

T4: 38 × 4,5

### Digitaldruck / Digital printing

—

### Filmtransfer / Film transfer printing

—

### Gravur / Engraving

—





”

**Zusammen Großes  
schaffen, gemeinsam eine  
Erinnerung daran teilen: Das  
hält ein Team zusammen.**

Creating great things together and  
sharing the memory of it:  
That's what keeps a team together.

# Füller & Tintenroller

Fountain Pens & Rollerballs





# Füller & Tintenroller

## Fountain Pens & Rollerballs



Soft Touch



Mix & Match



Biobasierter Kunststoff / Bio-based plastics



Recycling-Kunststoff / Recycled plastics



Preiskategorie € / Price Category €



Preiskategorie €€ / Price Category €€



Preiskategorie €€€ / Price Category €€€



Preiskategorie €€€€ / Price Category €€€€



4 154 Ray (Füller / Fountain pen)



4 156 Ray (Tintenroller / Rollerball)



2 158 One Business



1 160 Topball 863 Recycling



1 162 Topball 857 Recycling





# Ray Füller / Fountain pen



Tintenfarben/Ink colors

Füller mit ergonomisch gummiertem Griffprofil und hochwertiger Edelstahlfeder mit Iridiumkorn. Standard-Tintenpatronen königsblau löschbar.

Fountain pen with ergonomically rubberised grip profile and high-quality stainless steel nib with iridium tip. Standard ink cartridges, royal blue, erasable.

*Klimaneutral hergestellt.  
Produced climate neutrally.*

# Inspiration



## Farben Colours

Verfügbar ab / Available from:    ≥ 100 St. / pcs.    ≥ 100 St. / pcs.    ≥ 100 St. / pcs.  
Bestell-Nr. / Ref. No.:    968249    968203    968207

Kappe /  
Cap



G13/  
O70



G15/  
O27



G13/  
O10

Schaft /  
Barrel



G13/  
O70



G15/  
O27



G13/  
O10

## Druckflächen (in mm) Imprint positions (in mm)

Siebdruck / Screen printing

—

Tampondruck / Pad printing

T5: 38 × 7, T6: 38 × 7, T11: 20 × 6, T12: 20 × 6, T13: 40 × 6

Digitaldruck / Digital printing

—

Filmtransfer / Film transfer printing

—

Gravur / Engraving

G4: 33 × 5





# Ray Tintenroller / Rollerball



Tintenfarben/Ink colors

Tintenroller mit ergonomisch gummiertem Griffprofil und verschleißfester Edelstahlspitze.  
Standard-Tintenpatronen königsblau löschar.

Rollerball with ergonomically rubberised grip profile and wear-resistant stainless steel tip.  
Standard ink cartridges, royal blue, erasable.

*Klimaneutral hergestellt.  
Produced climate neutrally.*

# Inspiration



## Farben Colours

Verfügbar ab / Available from:    ≥ 100 St. / pcs.    ≥ 100 St. / pcs.    ≥ 100 St. / pcs.  
Bestell-Nr. / Ref. No.:    987849    987803    987807

Kappe /  
Cap



G13/  
O70



G15/  
O27



G13/  
O10

Schaft /  
Barrel



G13/  
O70



G15/  
O27



G13/  
O10

## Druckflächen (in mm) Imprint positions (in mm)

Siebdruck / Screen printing

Tampondruck / Pad printing

T5: 38 × 7, T6: 38 × 7, T11: 20 × 6, T12: 20 × 6, T13: 40 × 6

Digitaldruck / Digital printing

Filmtransfer / Film transfer printing

Gravur / Engraving

G4: 33 × 5





# One Business



#### Tintenfarben/Ink colors

Folgende Sondertintenfarben sind auf Anfrage erhältlich.  
The following special writing colours are available upon request.



Tintenroller mit Ultra-Smooth-Spitze. Ergonomisch gummierte Oberfläche. Cap Off-Tinte, kann 2-3 Tage offen liegen.  
Hochwertiger Metallclip. Schreibfarben sind dokumentenecht nach ISO 14145-2. Strichstärke 0,6 mm.

Rollerball with Ultra-Smooth tip. Ergonomically rubberised surface. Cap-off ink, can be kept open 2 to 3 days. High-quality metal clip. The ink colours are waterproof according to ink standard ISO 14145-2. Line width 0.6 mm.

*Klimaneutral hergestellt.  
Produced climate neutrally.*

# Inspiration



## Farben Colours

### Verfügbar ab /

Available from:  $\geq 100$  St. / pcs.

Bestell-Nr. / Ref. No.: 983001

$\geq 100$  St. / pcs.

983003

Kappe /  
Cap



G30/  
T10



G30/  
T31

Schaft /  
Barrel



G30/  
T10



G30/  
T31

Tinte / Ink:



Sondergehäusefarbe auf Anfrage / Special colours for pen body upon request  
Mindestmenge / minimum quantity:  $\geq 10.000$  St. / pcs.  
Bestell-Nr. / Ref. No.: 983099

Tinte enthält Konservierungsmittel C(M)IT/MIT /  
Ink contains the preservatives C(M)IT/MIT

## Druckflächen (in mm) Imprint positions (in mm)

### Siebdruck / Screen printing

—

### Tampondruck / Pad printing

T13: 35 x 8

### Digitaldruck / Digital printing

—

### Filmtransfer / Film transfer printing

—

### Gravur / Engraving

—



Update

# Topball 863 Recycling



**Tintenfarben** / Ink colors

Folgende Sondertintenfarben sind auf Anfrage erhältlich.  
The following special writing colours are available upon request.



Tintenroller aus opakem Kunststoff mit fein mattierter Oberfläche. Cap off-Tinte, kann 2–3 Tage offen liegen. Metallclip und Metallspitze 0,6 mm.

Rollerball in opaque plastics with matt surface. Cap-off ink, can be kept open 2 to 3 days. Metall clip and metal tip 0.6 mm.

*\*Gehäuse zu > 85% aus Recycling-Kunststoff. Klimaneutral hergestellt.*

*\*Pen body made of > 85% recycled plastic. Produced climate neutrally.*





# Inspiration



## Farben Colours

<b>Verfügbar ab / Available from:</b>	≥ 600 St. / pcs.	≥ 600 St. / pcs.	≥ 600 St. / pcs.	≥ 600 St. / pcs.	≥ 2.500 St. / pcs.
<b>Bestell-Nr. / Ref. No.:</b>	98636	98638	986303	986301	986399

**Farbauswahl / Select colour:**

Kappe mit Kappeneinsatz / Cap with cap insert								
	O70/ O10	O70/ O34	O10/ O10	O10/ O34	O70/ O10	O70/ O34	O10/ O10	O10/ O34
Stopfen / Plug								
	O10	O34	O10	O34	O10	O34		
Schaft / Barrel								
	O70	O70	O10	O10	O70	O10		
Adapter / Adapter								
	O10	O34	O10	O34	O10	O34		
Tinte / Ink:	●	●	●	●				

Sondergehäusefarbe auf Anfrage / Special colours for pen body upon request  
Mindestmenge / Minimum quantity: ≥ 10.000 St. / pcs.  
Bestell-Nr. / Ref. No.: 986399

## Druckflächen (in mm) Imprint positions (in mm)

### Siebdruck / Screen printing

S1: 58 × 28

### Tampondruck / Pad printing

—

### Digitaldruck / Digital printing

—

### Filmtransfer / Film transfer printing

—

### Gravur / Engraving

—

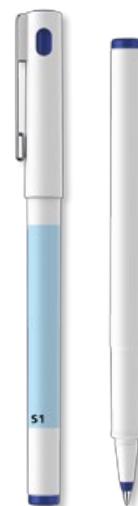

Update

# Topball 857 Recycling



**Tintenfarben**/Ink colors

Folgende Sondertintenfarben sind auf Anfrage erhältlich.  
The following special writing colours are available upon request.



Tintenroller aus opakem Kunststoff mit fein mattierter Oberfläche. Cap off-Tinte, kann 2–3 Tage offen liegen.  
Metallspitze 0,6 mm.

Rollerball in opaque plastics with matt surface. Cap-off ink, can be kept open 2 to 3 days. Metal tip 0.6 mm.

*\*Gehäuse zu > 85 % aus Recycling-Kunststoff. Klimaneutral hergestellt.*

*\*Pen body made of > 85% recycled plastic. Produced climate neutrally.*



# Inspiration



## Farben Colours

<b>Verfügbar ab / Available from:</b>	≥ 600 St. / pcs.	≥ 600 St. / pcs.	≥ 600 St. / pcs.	≥ 600 St. / pcs.	≥ 2.500 St. / pcs.
<b>Bestell-Nr. / Ref. No.:</b>	985701	985703	985720	985722	985799

**Farbauswahl / Select colour:**

Kappe mit Kappeneinsatz / Cap with cap insert								
	O70/ O10	O70/ O34	O10/ O10	O10/ O34	O70/ O10	O70/ O34	O10/ O10	O10/ O34
Stopfen / Plug								
	O10	O34	O10	O34	O10	O34	O10	O34
Schaft / Barrel								
	O70	O70	O10	O10	O70	O10		
Adapter / Adapter								
	O10	O34	O10	O34	O10	O34		
Tinte / Ink:	●	●	●	●				

Sondergehäusefarbe auf Anfrage / Special colours for pen body upon request  
Mindestmenge / Minimum quantity: ≥ 10.000 St. / pcs.  
Bestell-Nr. / Ref. No.: 985799

## Druckflächen (in mm) Imprint positions (in mm)

### Siebdruck / Screen printing

S1: 58 × 28

### Tampondruck / Pad printing

T4: 38 × 4,5

### Digitaldruck / Digital printing

—

### Filmtransfer / Film transfer printing

—

### Gravur / Engraving

—



# Etuis

## Wallets



Beschreibung / Description	Bestell-Nr. / Ref. No.	Farbe / Colour
<b>1 Geschenkverpackung (aus Karton) / Gift box (made of cardboard)</b> ohne Aufdruck / without imprint mit 4-farbigem Aufdruck / with 4-colour-imprint	9941 9942	weiß / white individuell / individual
<b>2 Stecketui / Wallet</b> für 4 Textmarker 150, 177 / for 4 highlighters 150, 177 für 4 Textmarker 180 / for 4 highlighters 180 viele weitere Stecketuis auf Anfrage / other wallets upon request	9977 9951	transparent transparent
<b>3 Einstecktasche (aus Karton) / Insert pocket (made of cardboard)</b> für 1 Schreibgerät / for 1 pen	9949	schwarz / black
<b>4 Polybeutel / Polybag</b> für 2 Link-It / for 2 Link-It für 4 Link-It / for 4 Link-It	9981 9982	transparent transparent

# Auszeichnungen

---

## Awards

---

### Promotional Gift Award 2021

Der Kugelschreiber Reco konnte schon mehrere Jurys überzeugen – jetzt auch die des Promotional Gift Awards, eine der angesehensten europäischen Auszeichnungen für Werbeartikel.

The ballpoint pen Reco has already convinced several juries – and now it has also won the Promotional Gift Award, one of the most prestigious European awards for promotional articles.



### PSI Sustainability Awards 2021

Unser Engagement im Bereich Nachhaltigkeit wurde bei den begehrten PSI Sustainability Awards gleich zweimal gewürdigt: in den Kategorien „Environmental Excellence“ und „Sustainable Product“.

Our commitment to sustainability has been honoured twice at the prestigious PSI Sustainability Awards: in the categories "Environmental Excellence" and "Sustainable Product".



# Technische Daten

## Druckvorlagen

Um Ihre Druckmotive und Logos entsprechend Ihrer Vorstellung auf dem gewählten Werbeschreibgerät optimal umsetzen zu können, ist die Qualität der uns zur Verfügung gestellten Druckvorlage für das Druckergebnis von wesentlicher Bedeutung. Wir möchten Ihnen nachfolgend einige kurze Hinweise geben, um die Arbeiten in der Druckvorstufe optimal realisieren zu können. Es gibt drei Möglichkeiten für Sie, uns Ihre Druckvorlagen zur Verfügung zu stellen:

### 1. Digitale Vorlagen

Beste Druckergebnisse und schnellste Umsetzung können mit digitalen Druckvorlagen erzielt werden. Diese werden in zwei Kategorien unterteilt:

#### Vektor-Dateien

Die einzelnen Bestandteile einer Vektor-Grafik werden aus randscharfen Grundelementen wie Kurven und Linien zusammengesetzt. Dadurch lassen sie sich stufenlos ohne Qualitätsverluste vergrößern bzw. verkleinern und kommen mit einem wesentlich geringeren Datenvolumen im Vergleich zu Bitmap-Grafiken aus.

Zu den bekanntesten Programmen zur Erstellung und Bearbeitung von Vektor-Grafiken gehören Corel Draw (.cdr) und Adobe Illustrator (.ai). Diese Formate sowie daraus erstellte EPS- oder PDF-Dateien können wir problemlos verarbeiten.

**Aber Achtung: In Vektor-Programmen abgelegte oder eingebundene Bitmaps sind keine Vektor-Grafiken!**

#### Bitmap-Dateien

Hier sind die Bildinformationen Punkt für Punkt gespeichert. Dadurch sind Bildvergrößerungen und -verkleinerungen mit deutlichen Qualitätsverlusten verbunden. Wir können Druckvorlagen im Bitmap-Format verwenden, diese sollten aber mindestens mit 1.200 dpi, bezogen auf die Original-Druckgröße, aufgelöst sein.

Zu den gängigsten Bitmap-Formaten zählen TIFF, PSD und JPG. Internet-optimierte Grafiken wie z. B. GIF eignen sich nicht als Druckvorlage, da diese gewöhnlich nicht für den Druck erforderliche Auflösungen haben, sondern lediglich Bildschirmauflösung!

**In Word, Power-Point und Excel eingebundene Vektor- oder Bitmap-Grafiken können nicht verwendet werden.**

### 2. Filme

Die klassische Form der Druckvorlage für Ihr Druckmotiv stellt der Tampon- bzw. Siebdruckfilm dar. Dieser muss 1:1 angelegt sein. Bei Mehrfarbdrucken sollte der Film aufgrund der Passerung der Farben zueinander mit sogenannten Passerkreuzen in den einzelnen Filmlagen versehen sein. Offset-Filme sollten aufgrund der Montage nicht zu knapp beschnitten sein, optimal ist ein Maß von 110 x 110 mm, innerhalb dem sich das Logo – unabhängig der Größe – befindet.

Da wir im Vorfeld meist noch nicht wissen, ob wir Sieb- oder Tampondruckfilme benötigen, sind digitale Vorlagen von großem Vorteil und ersparen eine weitere Repro.

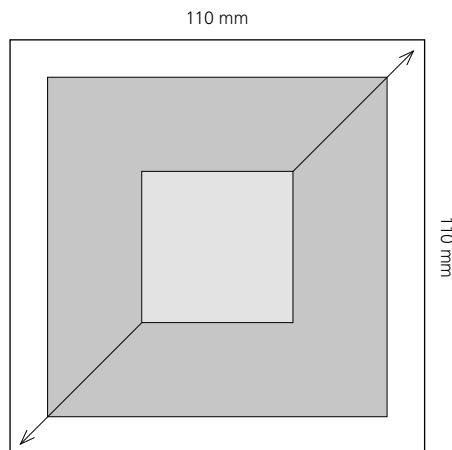

### 3. Reprofähige Vorlagen

Zur Filmerstellung benötigen wir von Ihnen eine reproduktionsfähige Vorlage, d. h. gute Reinzeichnung, gut gedruckter Briefbogen o. ä. – bitte nicht zu klein! Die Kosten für die Erstellung werden Ihnen nach Aufwand berechnet.

**Faxe und Fotokopien eignen sich nicht als Vorlage.**

## Schriftarten/-größen

Werden in Ihren digitalen Druckvorlagen Schriften verwendet, bitten wir Sie, diese in Kurven bzw. Pfade umzuwandeln, oder die Schriftarten als separate Dateien (True-Type-, Open-Type- oder Type 1-Fonts) Ihren Daten beizufügen.

Um eine einwandfreie Druck- und Lesbarkeit der Schriften zu gewährleisten, empfehlen wir eine Buchstabengröße ab 5 Punkt.

## Strichstärken

Die minimale Strichstärke bei Drucken beträgt 0,15 mm. Dünnere Strichstärken können aufgrund der technischen Voraussetzungen nicht realisiert werden.

## Druckfarben

Wir benötigen die Angabe der gewünschten Druckfarbe nach Pantone oder HKS. Liegt lediglich eine gedruckte Farbvorlage vor, bemühen wir uns, diese zu 100% zu treffen, können dies jedoch nicht garantieren.

Bei Drucken auf farbigen Gehäuseteilen empfehlen wir den Vordruck eines weißen Feldes um hierdurch eine bessere Deckung der weiteren Druckfarben zu erzielen. Ohne diesen Vordruck kann es zu Farbabweichungen kommen.

## Übermittlung von Daten

Sie können uns Ihre Druckdaten per E-Mail oder auf CD/DVD übermitteln. Bei Übermittlung der Daten per E-Mail fügen Sie diese in Ihrem E-Mail-Client als Anhang an und vermerken Sie bitte in der Mail, mit welchem Programm die Daten erstellt wurden. Zusammen mit weiteren relevanten Informationen senden Sie Ihre E-Mails bitte an: [viw@schneiderpen.de](mailto:viw@schneiderpen.de)

# Technical details

## Artwork

In order to perfectly create your imprint motifs and logos in accordance with your concepts on the selected promotional pens we need you to submit best quality artwork. In order to minimise your preparations we offer the following guidelines. There are three ways to submit your artwork:

### 1. Digital Data

The best alternative in the submission of artwork is to send it in the form of data or graphical data. Basically two categories exist within digital graphics:

#### Vector Graphics

In vector graphics the individual step of a graphic is built up from the basic elements such as curves, lines and then saved in the form of coordinates and mathematical vectors. This has the big advantage that the corresponding graphics enlarge or reduce without steps and without loss of quality. Additionally vector graphics need a lot less data volume compared to bitmaps.

Some of the more popular vector graphic programs are Corel-Draw (.cdr) and Adobe Illustrator (.ai). These programs as well as EPS or PDF graphics give the best results.

**Warning: Please note that the original bitmap files that are saved or placed in vector-programs are not vector-graphics and are therefore not suitable to produce final films!**

#### Bitmaps

The picture information is saved point by point. The disadvantage of bitmaps is that picture enlargements and reductions will result in considerable loss of quality. Artwork in bitmap format can be used, but it should have a resolution of a minimum of 1,200 dpi in reference to the original print size.

The most famous bitmap programs are TIFF, PSD and JPG. Internet graphics (e.g. gif) are not suitable for reproduction of artwork because they usually do not have sufficient resolution for printing.

**Warning: Bitmap graphics which are saved or placed in Word, PowerPoint or Excel are not suitable!**

### 2. Films

The classic form of the artwork for your imprint motif is a screen or offset-film. It must have the size of 1:1. For multiple colour prints please provide register marks for each film layer in order to fit the colours together. Offset films should not be cut too short. The optimum dimension is 110 x 110 mm, within which the logo is positioned regardless of size.

As we do not know in advance whether or not you need silk-screen or tampon films, electronic data is always advantageous and saves further delays.

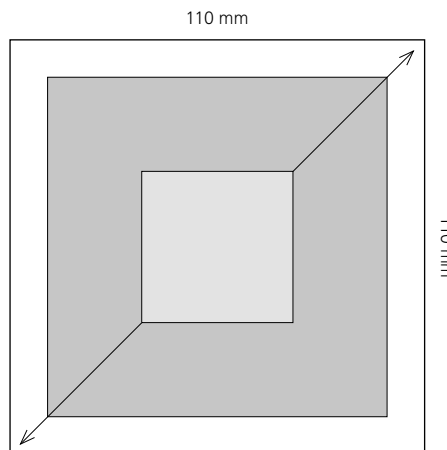

### 3. Reproducible Artwork

For producing the process films we need your best quality reproducible artwork, e.g. clear hard copy, good drawings, crisp prints etc. – and please, not too small!

**Please note that fax and photocopies can't be used.**

## Using Fonts in Digital Data

If you use fonts in your digital artwork, we kindly ask you to convert them to curves/vectors or to send the fonts as separate data (True-Type, Open-Type or Type1 Fonts).

In order to receive the best quality of legibility and imprint we recommend a font from 5 dots.

## Stroke Widths

The minimum stroke width for imprinting is 0.15 mm. We cannot imprint thinner stroke widths because of technical conditions.

## Imprinting Colours

Please indicate the required imprinting colours in Pantone or HKS. If we only can use a printed model we try to meet the colours to 100%, but without guarantee.

For imprints on coloured bodies we recommend the pre-imprint of a white field in order to receive a better covering of the following imprinting colours. Without this pre-imprint colours can differ from the requirement.

## Possibilities for Transmission

You can send us your imprinting data via E-mail or on CD/ DVD. If you wish to send us your files via E-mail please attach the data to your E-mail-client as an enclosure and indicate in your E-mail the program in which you have established the data. Together with all the other relevant information please send your E-mails to: viw@schneiderpen.de

# Druckpositionen

## Imprint positions

---

- 1 auf dem Schaft  
on the barrel
  - 2 auf dem Oberteil  
on the upper part
  - 3 auf dem Vorderteil  
on the front part
  - 4 auf dem Clip  
on the clip
  - 5 auf der Schaftvorderseite  
on the front side of the barrel
  - 6 auf der Schafrückseite  
on the back side of the barrel
  - 7 auf der Rückseite  
on the reverse
  - 8 vor dem Clip  
in front of the clip
  - 9 über dem Clip  
above the clip
  - 10 oben, seitlich vom Clip  
above, at the side of the clip
  - 11 auf der Kappe, rechts vom Clip  
on the cap, on the right side of the clip
  - 12 auf der Kappe, links vom Clip  
on the cap, on the left side of the clip
  - 13 auf der Kappenrückseite  
on the back side of the cap
  - 14 auf der Fensterhülse, links und rechts vom Clip  
on the outer sleeve, on the left + right side of the clip
  - 15 auf der Innenhülse, links und rechts vom Clip  
on the inner sleeve, on the left + right side of the clip
  - 16 auf der Banderole  
on the outside wrap
  - 17 auf der Stiftebox (Etikett)  
on the pencil case (label)
  - 18 auf der Platte  
on the cover plate
  - 19 auf dem Oberteil, rechts vom Clip  
on the upper part, on the right side of the clip
  - 20 auf dem Oberteil, links vom Clip  
on the upper part, on the left side of the clip
  - 21 auf dem Oberteil, rückseitig  
on the upper part, on the back side
  - 22 auf dem Vorderteil, rechts vom Clip  
on the front part, on the right side of the clip
  - 23 auf dem Vorderteil, links vom Clip  
on the front part, on the left side of the clip
  - 24 auf dem Vorderteil, rückseitig  
on the front part, on the back side
  - 25 auf dem Zwischenstück  
on the intermediate piece
  - 26 auf dem Zwischenstück, rechts vom Clip  
on the intermediate piece, on the right side of the clip
  - 27 auf dem Zwischenstück, links vom Clip  
on the intermediate piece, on the left side of the clip
  - 28 auf dem Zwischenstück, rückseitig  
on the intermediate piece, on the back side
  - 29 auf der Griffzone  
on the grip zone
- S Siebdruck  
Screen printing
  - T Tampondruck  
Pad printing
  - D Digitaldruck  
Digital printing
  - F Filmtransfer  
Film transfer printing
  - G Gravur  
Engraving



# Farberklärungen und Abkürzungen

## Colour descriptions and abbreviations

Nachfolgend erhalten Sie einen Überblick über die im Katalog verwendeten Kunststofffarben. Diese sind jeweils einem Pantonefarbton zugeordnet. Diese Farbangaben sind lediglich Richtwerte und dienen zur Orientierung. Abweichungen zu den original Kunststofffarben sind möglich. Um sicher zu gehen, fordern Sie bitte ein Muster im gewünschten Farbton an.

Below please find a list of the colours for the plastic parts used in the catalogue. They all are adjusted to a Pantone colour tone. These colour details are only approximate. They can differ from the original plastic colours. To avoid these discrepancies please order a sample in the required colour.

Schwarz / Black 10	Silber / Silver 11	Pantone Cool Gray 6 12	Pantone Cool Gray 11 13	Pantone 432 14	Pantone Cool Gray 1 15	Pantone 429 16	Pantone 179 21
Pantone 187 24	Pantone 186 25	Pantone 296 27	Pantone 7694 30	Pantone 7687 31	Pantone 2756 32	Pantone 297 33	Pantone 293 34
Pantone 662 35	Pantone 311 36	Pantone 7468 37	Pantone 298 38	Pantone 315 39	Pantone 342 40	Pantone 327 41	Pantone 3425 42
Pantone 347 43	Pantone 355 44	Pantone 361 47	Pantone 368 48	Pantone Yellow 50	Pantone 116 51	Pantone 130 52	Pantone 123 53
Pantone 809 54	Pantone 1255 56	Pantone 151 62	Pantone 811 63	Pantone 1585 64	Pantone 158 65	Pantone 7594 68	Pantone 7588 69
Weiß / White 70	Glasklar / Transparent 71	Pantone 806 90	Pantone 214 93	Pantone 237 95	Pantone 248 96	Pantone 259 97	Pantone 258 98

**G** gummiert / rubberised, **L** lackiert / lacquered, **M** metallic / metallic, **O** opak / opaque, **T** transparent / transparent

# Zeichenerklärungen

## Signs and Symbols



### Cap off

Die Stifte trocknen nicht ein, wenn sie 2–3 Tage offen liegen.

Can be kept open for 2 to 3 days without drying up.



### Dokumentenecht / For Documents

Die Schrift ist nach ISO-Normstandards "dokumentenecht" und somit fälschungssicher und radierfest.

The writing is permanent according to ISO standards for "documentary use".



### Wasser- und Lichtbeständig Water and light resistant

Die Schrift zerfließt nicht bei Kontakt mit Wasser und bleibt nach UV-Einstrahlung sichtbar.

The writing doesn't dissolve in water and remains visible after UV radiation.



### Dreieckiges Profil / Triangular shape

Schafft für jeden Finger eine deutliche Auflagefläche.

Defines exact position for each finger.



### Touchpen / Stylus-pen

Mit weichem Stylus-Käppchen für die Bedienung von Tablets und Smartphones.

With soft touch tip to operate on tablets and smartphones.

Benötigen Sie Hilfe bei der Auswahl oder haben Sie Fragen zu unseren Produkten? Mein Team und ich sind gerne persönlich für Sie da.

---

Do you need help with your selection or do you have questions about our products? My team and I are happy to help you personally.



---

**Klaus Broghammer**

+49 (0) 7729 - 888 124

[promotion@schneiderpen.com](mailto:promotion@schneiderpen.com)

Verkauf ausschließlich über unsere Handelspartner.  
We sell our products exclusively through trading partners.

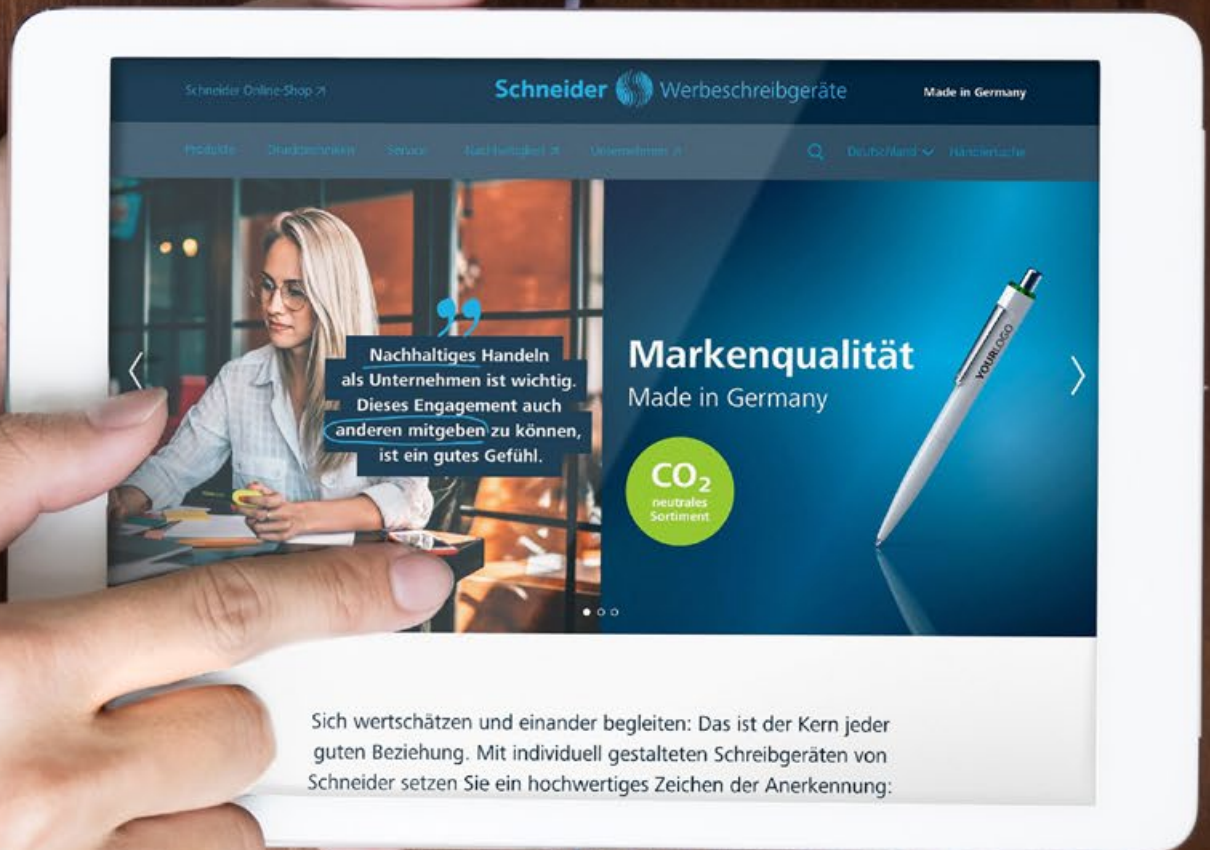

[schneiderpen-promotion.com](https://schneiderpen-promotion.com)

”

Eine kleine Aufmerksamkeit  
kann zu einem großen Zeichen  
der Wertschätzung werden.

A small gift  
can become a big symbol  
of appreciation.

Schneider Schreibgeräte GmbH  
Tennenbronn · Schwarzenbach 9  
78144 Schramberg · Germany

[schneiderpen-promotion.com](http://schneiderpen-promotion.com)

 **klimaneutral**  
natureOffice.com | DE-137-KQFA6SQ  
**gedruckt**

 **RECYCLED**  
Papier aus  
Recyclingmaterial  
FSC® C014405

Papier „Circleoffset Premium White“:  
FSC-zertifiziert, ausgezeichnet mit  
dem Blauen Umweltengel und EU  
Ecolabel.

503247 (deutsch/englisch)  
50-WM/003  
4004675159724